



## Ore Deposit Models #11. Archean Lode Gold Deposits

R. Gwilym Roberts  
Department of Earth Sciences  
University of Waterloo  
Waterloo, Ontario N2L 3G1

### Introduction

Approximately 60% of the World's cumulative gold production has come from rocks that are more than 2500 million years old. Eighteen percent of the cumulative production is from Archean lode deposits, and 40% from the paleoplacer deposits of the Witwatersrand of South Africa which were probably formed from the erosion of lode deposits.

The greenstone belts of all Archean shield areas are characterized by numerous lode gold deposits. The Superior Province is the largest and most productive of the Archean cratons. It has yielded 170 million ounces of gold from hundreds of deposits (Hodgson and MacGeehan, 1982), and the production from other Archean greenstone terranes is approximately proportional to their size. Examples of major producers occur in all the Archean shield areas of the World: the Superior and Slave Provinces of Canada (the mines of the Porcupine, Red Lake, Kirkland Lake, and Yellowknife districts); the early Precambrian Shield of Montana (the Homestake mine); the Brazilian Shield (the Morro Velho and Raposo mines); the Kaapvaal Craton and the Zambian Craton (the deposits of the Barberton Mountain Land and the deposits of the Gwanda and Midland belts); the shield areas of western Australia (the Golden Mile, Kalgoorlie); and the Indian Shield (the Kolar gold fields).

It is generally accepted that, compared to the Archean, lode deposits are scarce in the Proterozoic. However, the comparatively small number of deposits in the Apehian greenstone belts of the Canadian Shield, may be due to a lower level of exploration activity. Deposits with many of the characteristics of Archean lode deposits occur in the Mesozoic volcanic-sedimentary terranes of British Columbia (deposits of the Coquihalla, Bralorne-Pioneer, Cariboo, and Cassiar districts) and California (the Mother Lode), and in the Cambro-Ordovician greywackes and

shales of Nova Scotia (deposits in the Meguma group) and Victoria State, Australia (Ballarat-Bendigo district).

### Lithology of the Deposits

The deposits include a wide range of lithological and structural types. However, in general, the ores consist of veins (open space filling) and altered wall rock (replacement or metasomatism). The veins generally consist of coarse or "cherty" quartz with lesser amounts of albite and carbonate (typically ferroan dolomite), tourmaline, sericite and chlorite. In some systems, tourmaline or carbonate may be the principal constituent of the veins. Opaque minerals rarely constitute more than 5% of a vein. Pyrite is invariably present and is the most abundant sulphide; pyrrhotite and arsenopyrite are common, and other opaque minerals may include galena, sphalerite, chalcocopyrite, molybdenite, stibnite, tellurides and scheelite. In greenschist facies rocks, the altered wallrock immediately adjacent to the veins, is characterized by minerals that also occur in the veins: carbonates, quartz, sericite, albite and pyrite.

Typically, ore grade gold occurs in the veins, generally in small fractures in quartz, and in the wall rock where it is usually associated with iron sulphides. It is not uncommon for most or all the gold of an ore zone to be contained in wallrocks immediately adjacent to veins.

In replacement ore bodies, such as occur in the Campbell and A.A. White mines in the Red Lake district, (Andrews *et al.*, 1986), and in the Golden Mile deposits, Kalgoorlie (Phillips, 1986), quartz veins are a minor component. The ore zones consist of silicified mafic rock containing disseminated pyrite and arsenopyrite replacing and forming stringers in the mafic host. Disseminated gold also occurs in association with iron sulphide in magnetite-rich iron formations (the Lupin mine and B-zone Cullaton Lake in the Northwest Territories), and less frequently, in association with carbonates in chemical sediments (the Homestake deposit, South Dakota). In this type, gold-bearing quartz veins generally constitute a minor part of the ore.

### Regional Setting

**Lithological and Stratigraphic Relationships.** The relationship of gold deposits to host lithology and stratigraphic position has been addressed by Hutchinson (1976), Hutchinson and Burlington (1984), Hodgson and MacGeehan (1982) and Hodgson (1983). The deposits are confined to the volcanic-intrusive-sedimentary rocks of greenstone belts, and do not normally occur in the enclosing paragneiss. (The Renabie mine, near Wawa, Ontario, may be an exception.) Within the greenstone belt all lithologies are capable of hosting individual ore bodies, but the assemblage that most characterizes a gold mining district is mafic volcanic rocks with significant amounts of ultramafic komatiitic

flows, and sedimentary rocks of the greywacke-shale association. Felsic volcanic rocks are not normally significant, although there are exceptions such as the Red Lake district, Ontario, and the Malartic district in Quebec. However, felsic intrusive rocks, although not volumetrically significant at the scale of a mining district, have long been appreciated by prospectors for their spatial association with gold deposits. Hodgson and MacGeehan (1982) estimate that more than 90% of the larger deposits of the Superior Province (deposits with production greater than one million ounces) are hosted by, or are immediately adjacent to, felsic porphyries. Cherry (1983) estimates that 70% of the gold of the Kirkland Lake-Larder Lake district, Ontario, and 60% of the gold of the Porcupine district, Ontario, is from deposits with a strong association with felsic intrusions. A similar association has been noted from the Red Lake district, Ontario (Pirie, 1981), Malartic - Val d'Or, Quebec (Latulippe, 1982) and the Yellowknife district, Northwest Territories (Boyle, 1961; Helmstaedt and Padgham, 1986). In the Kirkland Lake district, Ontario, a suite of syenitic intrusions that host the deposits, intrude trachyte flows and trachytic tuffs, which, on the basis of chemical composition are described by Cooke and Moorhouse (1969) and Kerrich and Watson (1984) as being co-magmatic. A comparable co-magmatic relationship, on the basis of petrographic and geochemical similarities, has been proposed for the pyroclastic Krist Formation and the quartz porphyries associated with many of the deposits of the Timmins district, Ontario (Karvinen, 1981; Pyke, 1982; Gibson *et al.*, 1982). However, recent age dating quoted in Wood *et al.* (1986), indicates that approximately 15 m.y. elapsed between the end of volcanic activity and the emplacement of the porphyries.

There is no evidence of stratigraphic control to gold deposits within the komatiitic-tholeiitic successions. In the Timmins district, the deposits are distributed throughout the komatiitic to iron-rich tholeiitic flow rocks of the Tisdale Group (over 3500 m thick), and into the sedimentary rocks of the overlying Porcupine Group. A similar lack of stratigraphic control was noted by Hutchinson and Burlington (1984) for deposits adjacent to the Cadillac break in the Noranda district of Quebec.

Gold deposits in iron formations may be stratabound in as much as each individual deposit may be more or less restricted to a sedimentary unit or facies, but there is no evidence that the deposits of a district are restricted to a stratigraphic interval in the way that volcanogenic massive sulphide deposits are. For example, gold-bearing iron formations of the Point Lake basin of the Slave Province occur throughout the Contwoyto Formation (Gibbins, 1981).

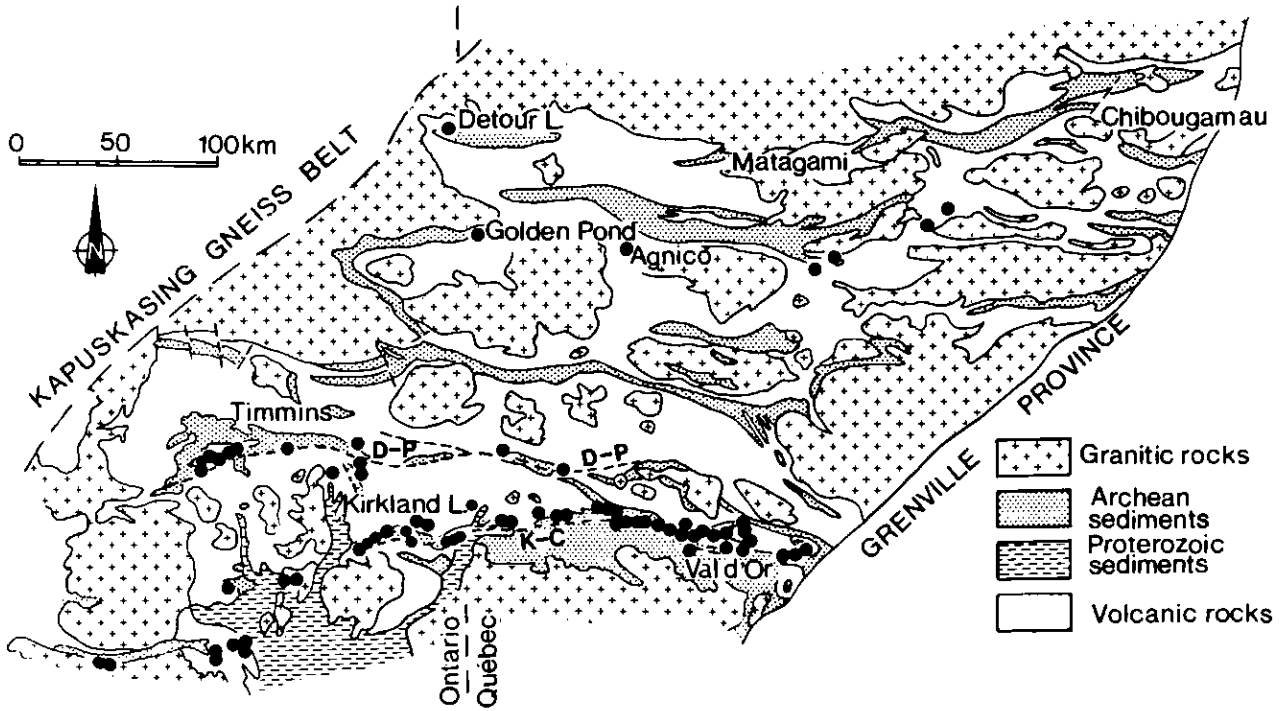

**Figure 1** The distribution of gold deposits in the Abitibi greenstone belt. D-P: the Destor-Porcupine Fault; K-C: the Kirkland Lake-Cadillac break (After Goodwin and Ridler, 1970, *MERO-GGS*, 1983; Latulippe, 1982, and other sources).

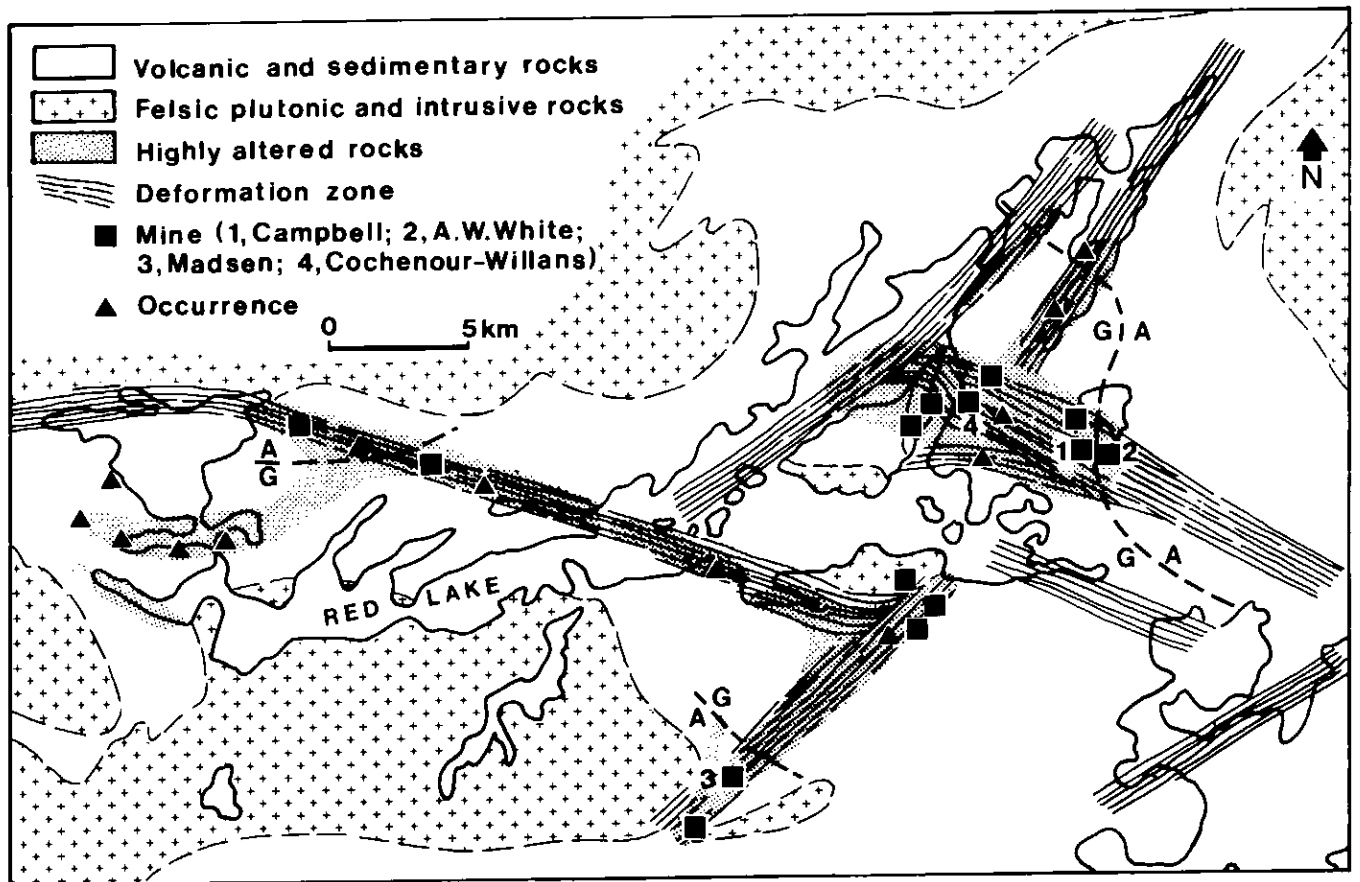

**Figure 2** The relationships of the gold deposits and regional alteration to deformation zones and major felsic plutons in the Red Lake district, Canada. G/A indicates the greenschist-amphibolite facies isograd. (After Andrews et al., 1986).

**Regional Structural Relationships**

The association of gold deposits with regional faults or "breaks" was appreciated by early explorationists. It is illustrated by the concentrations of deposits about the Destor-Porcupine and Kirkland Lake-Cadillac fault systems in the Abitibi belt of Ontario and Quebec (Figure 1), and about the regional faults in the Wabigoon Province in western Ontario (Poulsen, 1983). It is now appreciated that the gold deposits are related to steeply dipping planar shear zones of brittle to ductile deformation, and that the regional

faults are a manifestation of brittle deformation within these zones of anomalously high strain. The significance of this is demonstrated by the distribution of deposits in the Red Lake district, Ontario, (Figure 2) where, until recently, it had not been possible to show a relationship between regional structures, specifically faults, and gold deposits (Pirie, 1981; MacGeehan and Hodgson, 1982). However, Andrews and Wallace (1983) and Andrews *et al.* (1986) have shown that the deposits are related to planar, deformation zones, or shear zones, of brittle-ductile strain.

The shear zones are regional structures, generally sub-parallel to the volcanic stratigraphy, up to several kilometres wide and may be well over 100 km long. They consist of zones of faulting and intense shearing that may be sub-parallel and relatively continuous or anastomosing, enclosing islands of relatively unstrained rocks. The kinematic and strain indicators, such as foliations, stretch lineations and asymmetrical strain shadows around minerals indicate that deformation has been principally by simple shear strain.

The volcanic strata in the terranes between the shear zones, are typically sub-vertical and folded, but the foliations and lineations, indicative of tectonic flattening and stretching are, as a rule, only locally developed. Deformation culminated in the Kenoran Orogeny with folding and tectonic shortening across the volcanic basin. In western and north-western Ontario, and in the Yellowknife district, the deformation has been ascribed to the diapiric rise of granitic plutons (Schwerdtner *et al.*, 1979; Boyle, 1961; Helmstaedt and Padgham, 1986; Andrews *et al.*, 1986). In these districts, the gold-bearing shear zones are related to the same period of crustal shortening, and developed as conjugate systems in which the principal direction of shortening is into the obtuse angle of the intersecting shears.

The regional structures of the Abitibi belt have a somewhat different history of deformation. Dimroth *et al.* (1982) and Jensen (1985) describe the Destor-Porcupine and Kirkland Lake-Cadillac fault systems as growth faults, or normal faults, that developed during the early stages of volcanic activity, presumably under an extensional regime. They suggest that the associated belts of turbidite-greywacke sediments are related to the history of movements on the faults. As growth faults, they may well define the limits of volcanic terranes that developed with varying degrees of independence such that volcanic and sedimentary units periodically overlapped them. Archambault (1985) has proposed that during the Kenoran orogeny, shortening across the Abitibi belt, in a north-south stress field, was achieved by folding of the volcanic terrane about east-trending axes, followed by faulting and shearing with reverse sense of movement on the Destor-Porcupine and Kirkland Lake-Cadillac fault zones as the isoclinal folds became locked in, and finally by the development of east-northeast and west-southwest conjugate shear and fault systems within the volcanic terrane. Thus the principal gold-bearing shear zones of the Abitibi belt are similar to those of the greenstone belts of northwestern Ontario and the Yellowknife district in that they are late tectonic structures, but differ in that their location is apparently controlled by the earlier (probably volcanic) structures.

It is probable that other sedimentary belts at the margins of the Abitibi greenstone belt and

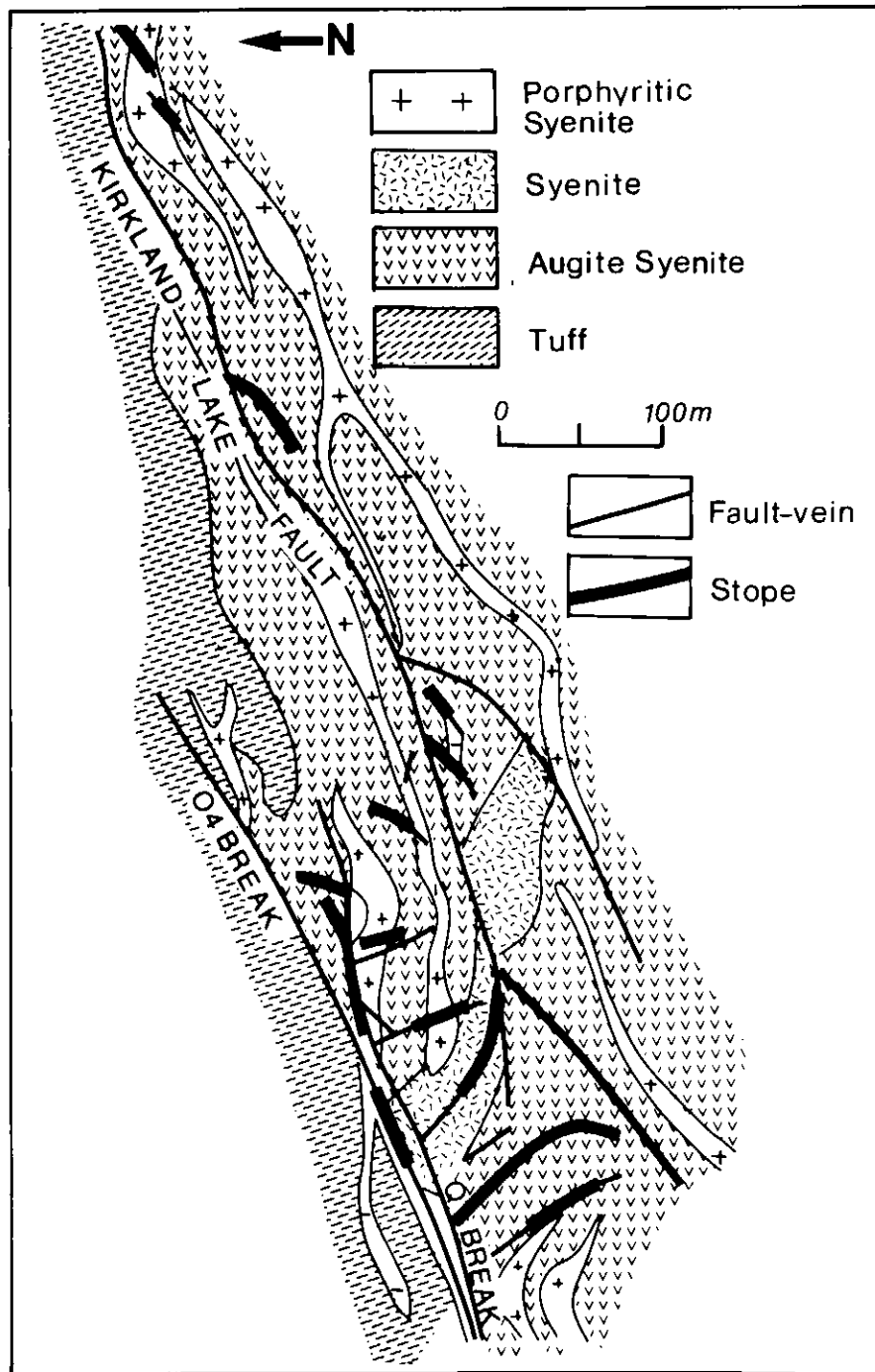

**Figure 3** A section through the Macassa deposit, Kirkland Lake, Ontario (looking eastward). The top of the section is approximately 850 m below surface. (After Charlewood, 1964).

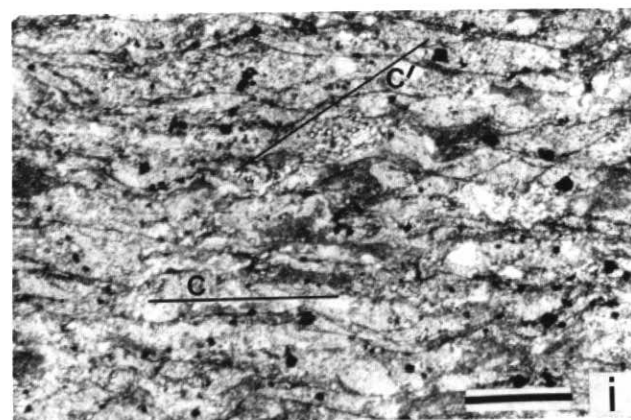
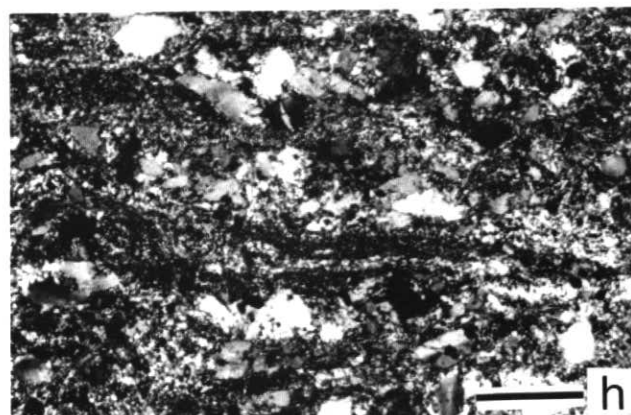
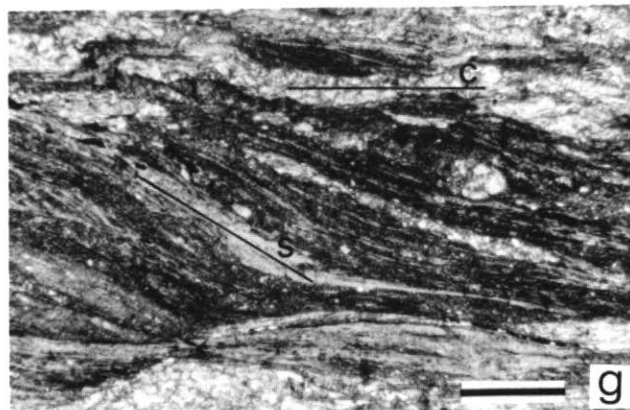
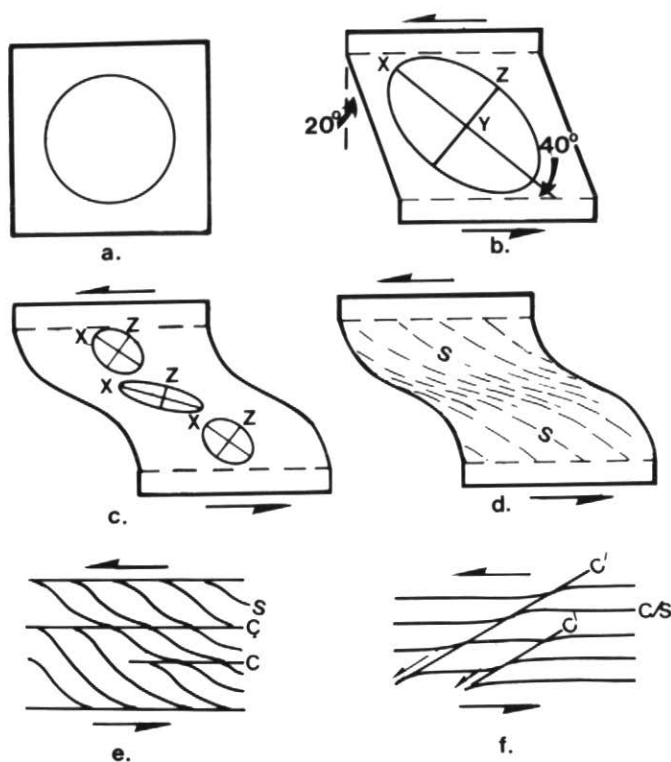

**Figure 4** The development of foliations by simple shear strain in a ductile shear zone.

(a) The undeformed state.

(b) Deformed by homogeneous simple shear strain, showing the orientation of the finite strain ellipsoid. A penetrative foliation forms in the XY plane of the strain ellipsoid, the plane of flattening.

(c) and (d) Heterogeneous simple shear under conditions of low bulk strain.

(c) The variation of the orientation and shape of the finite strain ellipsoids through the shear zone.

(d) The variation of attitude and intensity of the penetrative foliation S, developed in the planes of flattening of the finite strain ellipsoids across the shear zone.

(e) and (f) Heterogeneous simple shear strain under conditions of high bulk strain (after Simpson, 1983).

(e) The C foliation, a spaced foliation, developed as planes of shear parallel to the walls of the shear zone. S is rotated into C.

(f) The development of C' (shear banding); the spaced foliation transects C foliation in highly strained rocks.

(g) to (i) Photomicrographs of thin sections illustrating the foliations developed around the H-zone, Upper Canada mine, Ontario; scale bars are 5 mm.

(g) C and S foliations developed in sheared trachyte enclosing the ore body. Plane light; dark areas are mainly chlorite, light areas are feldspar, quartz and minor carbonate.

(h) The H-zone ore, protomylonitic trachyte, is at the most highly strained part of the shear zone; the C foliation is defined by the fine-grained cataclastic quartz and feldspar. Crossed nicols.

(i) A prominent fabric interpreted as C' foliation developed in the protomylonitic trachyte of the H-zone ore. Plane light.

within the greenstone belt, indicate growth faults, and have the same significance for the location of gold deposits as the Destor-Porcupine fault. The locations of the Golden Pond and Detour Lake deposits appears to support such a supposition (Figure 1).

The porphyries in the Abitibi belt are concentrated in the deformation zones. This is particularly evident in the Porcupine district where several porphyry bodies are precisely located in structural discontinuities.

**Structural Geology of the Vein Systems**

The structural geology of the lode deposits is, in many respects, a scaled-down version of the structural geology of the greenstone belt. The vein systems occur in the central parts of discrete shear zones within the larger regional shear zones where rotational or simple shear strain predominates, but individual veins may extend laterally beyond the sub-vertical shear zone, for a limited distance, into the enclosing, less deformed rock where deformation is probably by pure shear strain. Veins may also occur in dilation zones associated with folding.

Vein systems are tabular, sub-vertical structures. Typically, the thickness of a vein system is measured in metres, and its strike and dip dimensions measured in tens or hundreds of metres (Figure 3). The economically viable part of the vein system may be considerably smaller. The vein system, in turn, may be part of a larger geological structure which consists of a system of discrete shears each hosting a vein system. For example, the seven mines of the Kirkland Lake district, Ontario, are located on a continuous vein-bearing shear system that has a strike length of 5 km, a width of 450 m, and extends for a vertical depth of at least 2 km.

**Vein Systems in Shear Zones.** The significance of shear zones to the location and geometry of vein systems was recognized by many of the early investigators, but most of the early studies did not explain the geometry of the veins, and the minor structures of the shear zones in terms of the assumed deformation process. Fortunately, the recent renewal of interest in Archean lode gold deposits has coincided with a resurgence of

shear zone studies. The application of the results of these studies has confirmed the findings of earlier geologists, and has shown that the internal structures and geometry of many vein systems may be explained in terms of the development of a simple shear strain system.

Ramsay (1980) has classified shear zones into brittle, brittle-ductile and ductile. Brittle shears are characterized by the abrupt offset of markers, and are associated with faults and breccias. Ductile shears are characterized by continuous offset, and the development of mylonites. Brittle-ductile shear zones are associated with the development of strong foliation. In as much as mylonite is a cataclastic rock, it may be argued that the distinction between brittle and ductile is a question of the scale of observation. Most shear zones show evidence of both brittle deformation and ductile deformation, developed at different times in the history of the shear zone. The transition from ductile to brittle may occur as a consequence of an increase in the competency of the rock through which the shear zone passes, an increase in the rate of strain, or an increase in the pore pressure in the shear zone. The development of fabrics (and their kinematic significance) in a brittle-ductile shear zone, culminating in a mylonitic zone is illustrated in Figure 4.

The sequential formation of fractures in a shear zone, and their orientation, were first described in 1929 by Riedel in a series of experiments, which were later confirmed by Tchalenko (1968). Although the experiments modelled brittle shear, the structures can be recognized in brittle-ductile regimes. The orientation of the shear fractures, and the sense of movement across them, are illustrated in Figure 5. The low-angle Riedel shears (R) and the high-angle Riedel shears (R') are the first fractures to form, followed by reverse shears or pressure shears (P), and finally the D shears which occupy the central part of the shear zone. Extensional fractures (T in Figure 5), form during shearing in a plane perpendicular to the X axis of the strain ellipsoid at any instant of strain. They will thus tend to transect the shear zone and be oriented at a

high angle to the foliation. Veins in the shear fractures are generally larger and, economically, more significant than extension veins.

In several recent studies of vein systems, the veins have been identified as being in the position of the D, P, R and R' shears. Examples include: the Duport mine, Ontario (Smith, 1986), the Sigma mine, Quebec (Robert *et al.*, 1983), various deposits in the Red Lake district (Hugon and Schwerdtner, 1985; Andrews *et al.*, 1986), Cochenour-Willans mine, Red Lake (Sanborn and Schwerdtner, 1986) and in the Sturgeon Lake District (Poulsen and Franklin, 1981).

The interpretation of the fabrics and the vein geometry in terms of the shear zone model in the above examples is significant because it identifies the fundamental nature of the deformation process, and may be of value in predicting the attitude and even the location of the ore shoots. The long dimensions of some of the ore bodies described by Andrews *et al.* (1986) from the A.A. White, Cochenour-Willans and Campbell mines are parallel to the stretch lineations (the X-axis of the strain ellipsoid, Figure 6). By contrast, the ore shoots in shear zones in the Star Lake pluton, Saskatchewan, closely parallel the intermediate axis of strain (Poulsen *et al.*, 1986). This direction is parallel to the lineation formed by the intersection of the S and C foliations in Figure 6, and would also parallel the intersection of any subsidiary shear with the main shear zone (Poulsen *et al.*, 1986). In the Cameron Lake deposit, Ontario, Melling *et al.* (1986) have shown that the location and attitude of the gold zones are controlled by the intersection of bedding-controlled splay shears with the Cameron Lake Shear Zone.

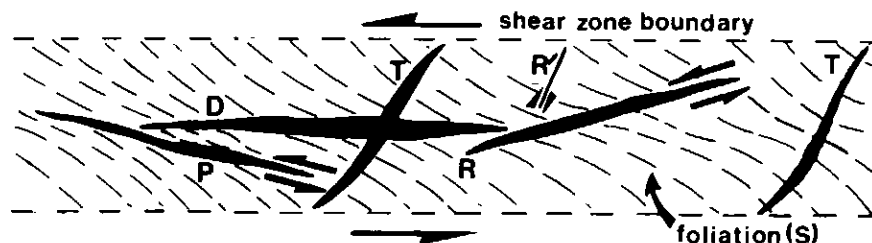

**Figure 5** The orientation of shear fractures and extension fractures in a brittle-ductile shear zone. The fractures are shown occupied by veins. R, low-angle Riedel shear fractures, 15 degrees to shear zone boundary; R', high-angle Riedel shear fractures, 75 degrees to SZB; P, shear fractures or reverse fractures, 15 degrees to SZB; D, principal shear fractures, parallel to SZB; T, extension fractures, form in YZ plane of the strain ellipse, perpendicular to the S foliation.

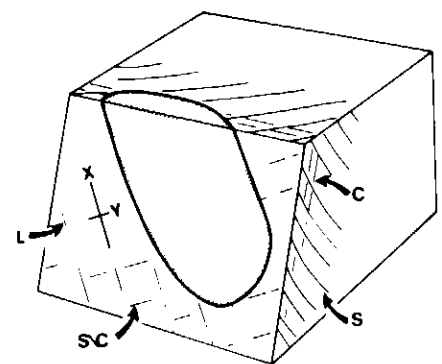

**Figure 6** The relationship between the fabrics (the axes of the finite strain ellipsoid) and the ore shoot. The ore shoot is parallel to the X axis of the finite strain ellipsoid, i.e. the stretch lineation. See text for examples of ore shoots parallel to the lineation formed by the intersection of S and C foliations.

Generally, the pattern of the vein system is complicated by the formation of different types of veins (and consequently at different attitudes), more or less contemporaneously, and by the sequential emplacement of veins as deformation progresses. The formation of veins in extension fractures, contemporaneously with veins in shear fractures is illustrated in Figure 7a. The extension veins may terminate against the larger veins in shear fractures (generally in P or D shears), or merge continuously with them to form a discrete vein or a layer within a vein. Robert *et al.* (1983) describe sub-horizontal extension veins in the Sigma mine that extend beyond the limits of the sub-vertical shear zones for as much as 75 m. The authors suggest that the extension veins form in the YZ plane of the strain ellipse in the region of plane strain, outside the shear zones (Figures 7b and 3).

Early formed veins may be deformed as shearing progresses, and may be cut by later generations of veins. Veins oblique to the direction of shear are rotated, boudinaged and folded by the mechanisms shown in Figure 8, and they may also form similar folds as the result of differential shear. The larger veins in many shear systems are in P or D shear fractures, and, because they are in the plane of shearing, or approximately in the plane of shearing, they are rarely folded, although they may be pulled apart and boudinaged. The net result is that the shear zone may contain folded veins, boudinaged veins, folded and boudinaged veins, together with veins that are apparently not strained.

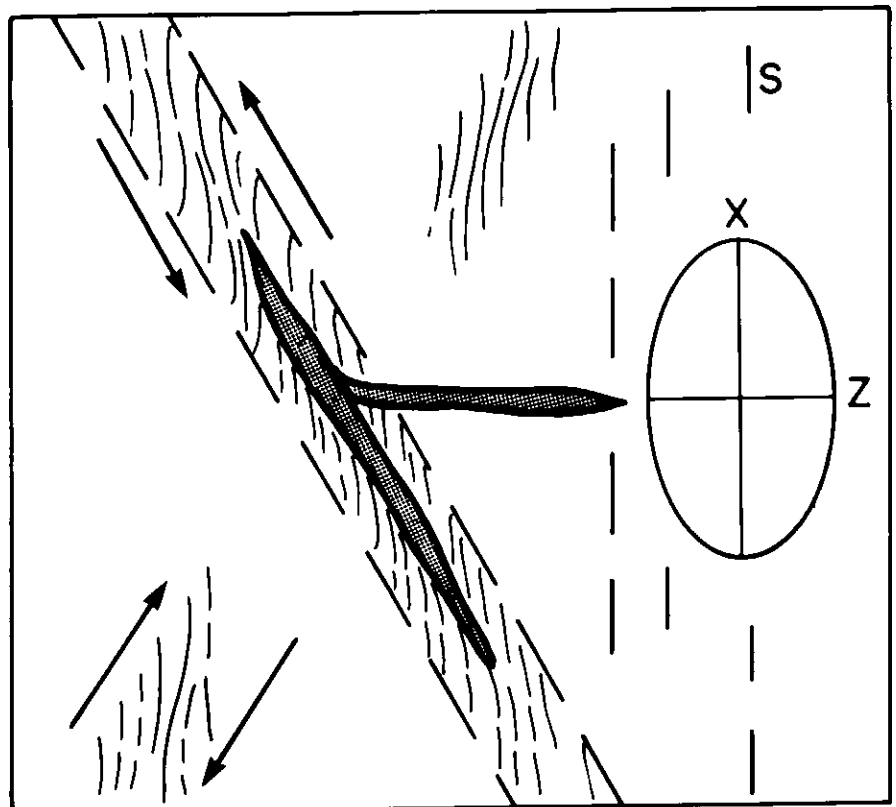
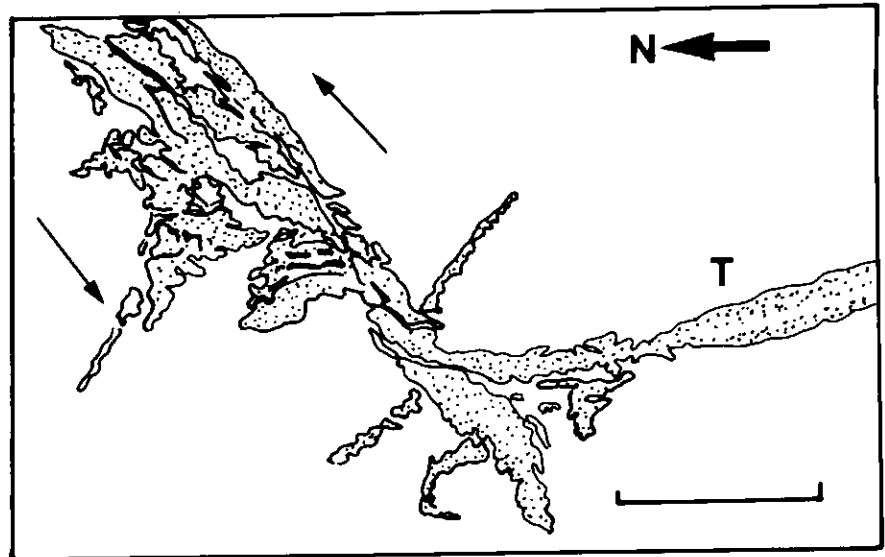

**Figure 7 (a) (upper right)** Vein in extensional fracture, T, merging with veins in the sub-vertical shear zone (Sigma mine, Quebec, Robert *et al.*, 1983). Bar is one metre.

**(b) (middle right)** The relationship between the flat veins and the bulk strain at the Sigma mine. Veins in the extension fractures pass from the shear zone into the area of irrotational strain. The veins are perpendicular to the X axis of the strain ellipse, and contain the Z axis, which bisects the obtuse angle of the conjugate shears.

**(c) (lower right)** A vein system at the Hollinger mine, Ontario (drawing from a photograph in Michie, 1967). Extensional veins pass into veins that are oblique to the attitude of the main vein system. The oblique veins are interpreted as P veins. Bar is one metre.

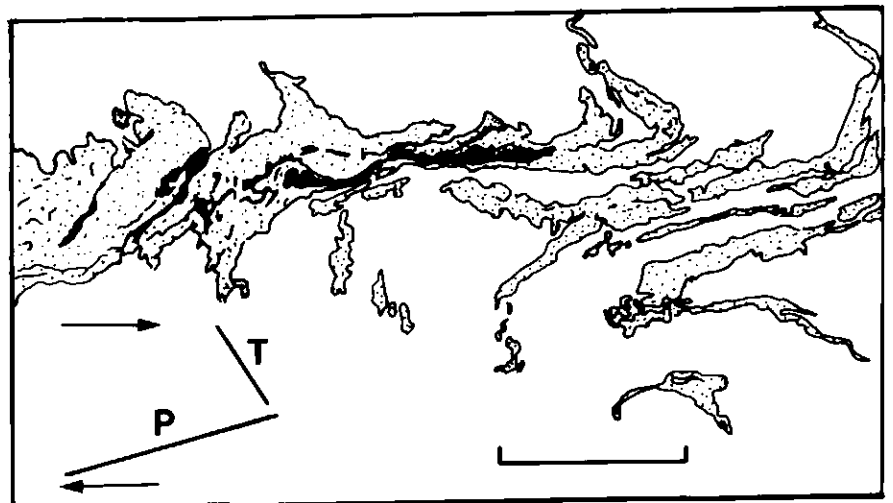

Veins in shear fractures are typically layered, and the layering is usually ascribed to repeated opening and filling of the structure. Veins in extension fractures are generally not layered suggesting that they formed as a single event. Extension fractures may be expected to dilate since they originate in a plane perpendicular to the direction of maximum extension of the strain ellipsoid. The P and R shear fractures are oblique to the principal direction of shearing, and as such, have the potential for dilation and vein formation, as shearing progresses. Guha *et al.* (1983) have shown that voids and open spaces may be created in ductile shear zones during the overriding and irregularities of different scales as shearing proceeds.

In some ore zones, veins are not developed. The gold occurs as pervasive disseminations and its location is controlled by the degree of strain in the rocks. For example, the H-zone of the Upper Canada mine, Kirkland Lake, is in a ductile shear zone in which the highest grade ore is confined to a comparatively narrow mylonitic rock (Fig. 4h) enclosed in less strained rocks in which S and C foliations are developed (Fig. 4g). Hemlo and the replacement bodies in the Red Lake district may be "other" examples of gold ore bodies in ductile deformation zones. Ore bodies of this type suggest that grain size reduction and the fracturing of grains associated with mylonitization, may promote permeability in the rocks.

From the above description, it is apparent that the formation of veins is a part of the deformation process. Shearing does not appear to be a ground preparation process during which open structures are formed, and into which veins are later emplaced; rather, shearing and veining are parts of a continuous process. The continuity of vein formation throughout the history of the shear zones implies fluid circulation, or the availability of the fluid, over a long period of time. It is also apparent that the shear zones that

host the gold deposits do not involve large displacements; even though in some situations, they may be adjacent to regional structures. This is illustrated in the Dome mine, Ontario, where vein-bearing shear zones transect an unconformity at a high angle, with negligible displacement. It is probably more reasonable to consider the shear zones as structures that accommodated the shortening of the greenstone belt, rather than structures on which large displacements occurred. In this sense, they are analogous to folds.

A structural environment of simple shearing should not always be assumed. These processes have not been recognized in the vein deposits associated with the Paleozoic shales and greywackes of the Meguma Group in Nova Scotia, and the Ballarat-Bendigo district of Victoria, Australia. In these deposits, the veins have been shown to be related to the fold history of the region under compressive stresses. Bedding-parallel veins in the Meguma Group formed at the onset of horizontal compression at the early stages of deformation, and vein formation continued to the later stages of folding (Graves and Zentilli, 1982). The saddle reefs of the Ballarat gold field formed in zones of dilation produced by delamination of beds at the hinges of folds (Baragwanath, 1953). The Camlaren deposit in greywackes of the Yellowknife Supergroup, is an example of gold-bearing veins in saddle reef structures in Archean rocks (Boyle, 1979; Padgham, 1981). **Gold in Chemical Sedimentary Rocks.** The lithologies that have been interpreted as evidence for syngenetic or exhalative gold, precipitated in association with chemical sediments, generally fall into two categories: gold-bearing, laminated units in volcanic rocks; and gold-bearing, iron sulphide-rich units in banded iron formation. In Canada, examples of gold-bearing laminated units that have been interpreted as sediments include: the ankerite units at the Dome and Aunor mines (Fryer and Hutchinson, 1976;

Fryer *et al.*, 1979; Karvinen, 1981; Roberts, 1981); the ESC ore zone, Dickenson mine (Crocket *et al.*, 1981; Kerrich *et al.*, 1981); the Agnico-Eagle deposit (Barnett *et al.*, 1982); and the Bousquet deposit (Valliant *et al.*, 1982). Similar gold-bearing units have been described from the Barberton Mountain Land (Viljoen, 1984; Ward, 1984) and Western Australia (Fehlberg and Giles, 1984). The sedimentary origin for the laminated structure of these units has been brought into question by the re-interpretation of the ESC zone at Dickenson as a shear zone (Rigg and Helmstaedt, 1981; MacGeehan and Hodgson, 1982; Mathieson and Hodgson, 1984), and on the basis of sulphur isotopic studies by Lavigne and Crocket (1983). The syngenetic interpretation of the ankerite units at the Dome and Aunor mines has been questioned by Hodgson (1983) and Macdonald (1984).

The ankerite units at the Dome mine consist of layers, typically 1-15 cm thick, of ferroan dolomite, chert, tourmaline-quartz, pyrite, and schistose, altered mafic material. Pyrite generally occurs as thin laminations in schistose, altered mafic rock. The layers are parallel to the foliation of the enclosing schistose, altered mafic rock, and have been interpreted as primary sedimentary structures. Coarse-grained quartz veins, with minor amounts of tourmaline, carbonate and pyrite occur in the units, both conformable and disconformable to the laminations of the units. In terms of the syngenetic model, the coarse quartz veins are assumed to have been emplaced during the post-depositional history of the units, principally during metamorphism (Hutchinson and Burlington, 1984; Roberts, 1981). However, the structures of the laminated ankerite unit shown in Figure 9 are more reasonably interpreted as a vein system. The ankerite unit is a narrow, ductile shear zone. The foliation in the wall rock (S foliation) is deflected into the schistosity of the ankerite unit which is the C foliation of the shear zone. The attitudes of the foliations indicate a left-handed horizontal component. The folds in the C foliation of the ankerite unit are comparable to sheath folds developed in a ductile shear (Platt, 1983). The folds also indicate a left-handed sense of movement. The layers of ankerite, chert, etc., which characterize the unit, were emplaced parallel to the C fabric during the ductile shear deformation, and are incorporated into the sheath folds. The coarse quartz veins were emplaced at various stages, during a later brittle-ductile phase of shearing.

The interpretation of the ankerite units at the Dome mine, and other gold-bearing laminated units referred to above as vein systems in shear zones, places in doubt the sedimentary status of other, similar structures. No doubt these will be re-examined with the shear zone model in mind.

Gold in banded iron formation presents a different problem in that there is generally no question of the sedimentary character of the

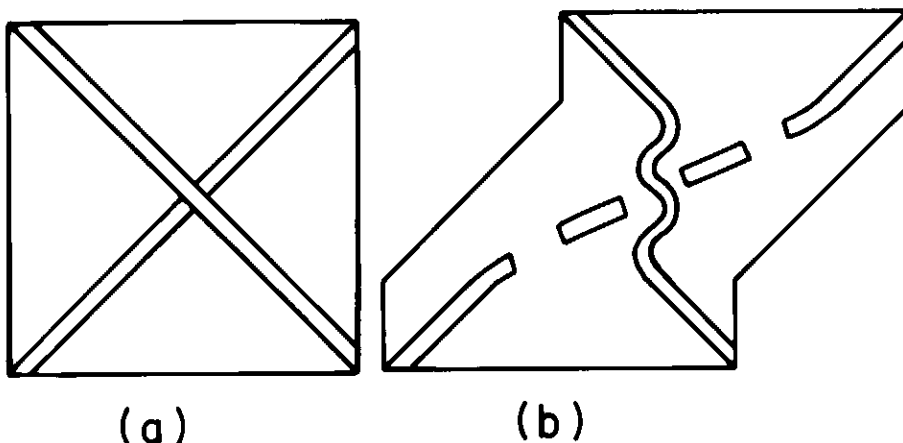
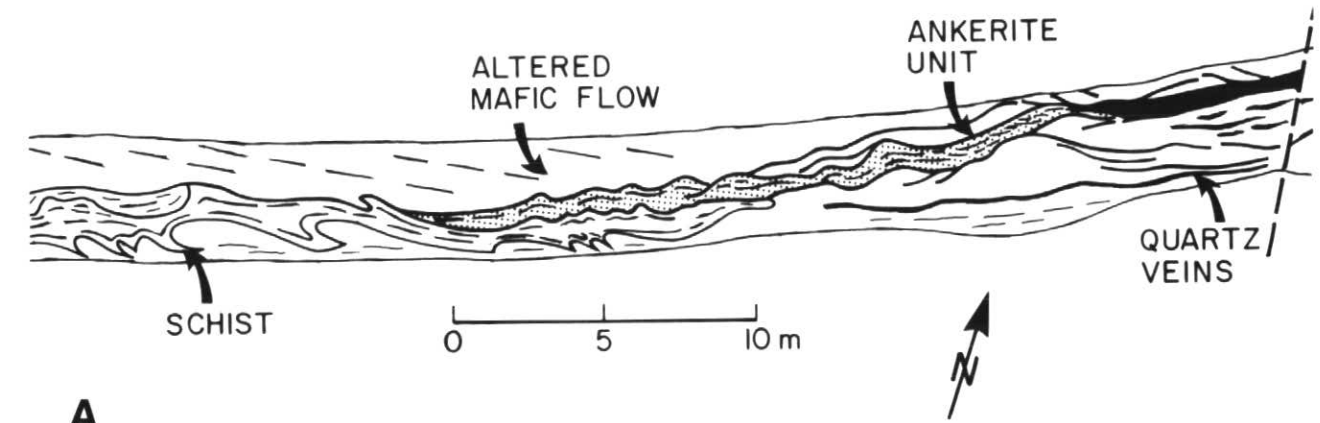
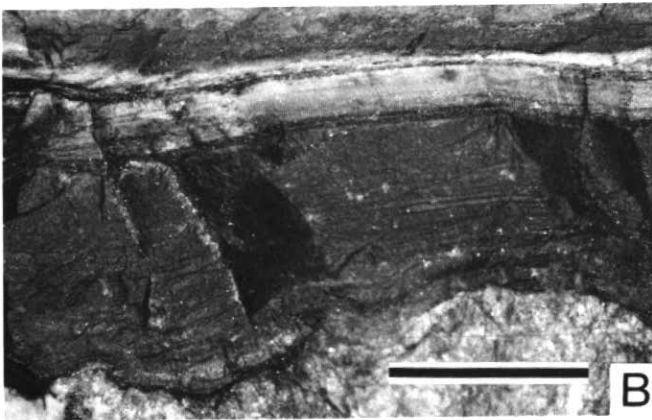

Figure 8 (a) and (b) show how veins may be boudinaged or folded by buckling within in the shear zone. With continued deformation, the folded vein will become boudinaged. (After Ramsay, 1980).



A



B

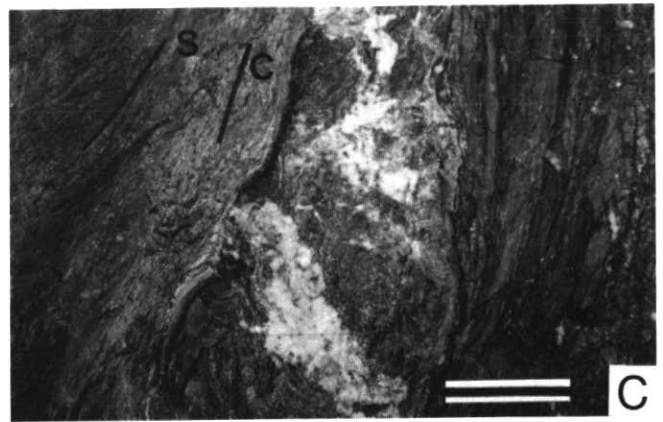

C

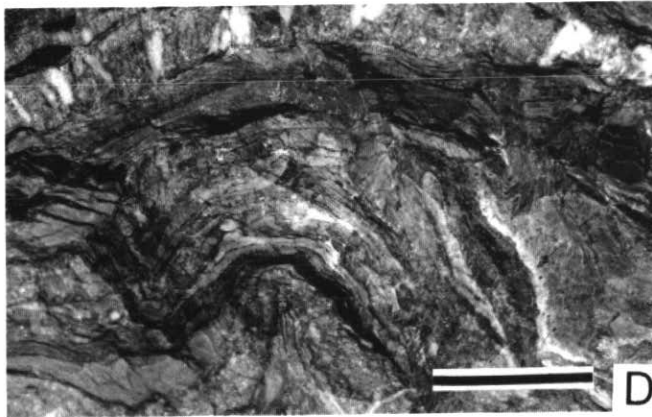

D

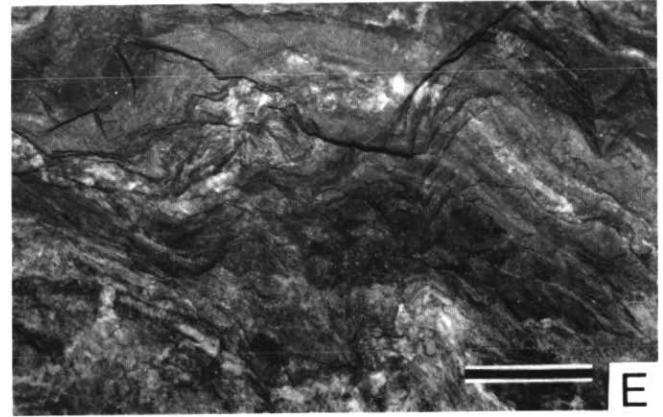

E

**Figure 9** (A) Map of an ankerite unit in pillowed mafic flows, in a drift on the 12th level, Dome mine, Timmins. Foliation is indicated by dashed lines. The foliation in the ankerite unit and the host schist is a C foliation. The foliation in altered mafic flow is a S foliation. The attitude of the two foliations indicates a shear with a left handed component of movement in the horizontal plane. The geometry of the folds in the ankerite unit and host schist are compatible with the same sense of shear. (B) The laminated structure of an ankerite unit; bar is 25 cm. The light coloured layer (upper) consists of interlaminated tourmaline and chert; dark layer (centre) consists of schistose, altered mafic material and laminations of pyrite; light coloured layer (lower) consists of ankerite (ferroan dolomite) and quartz. (C) Horizontal section of an ankerite unit; bar 10 cm. The attitudes of the S and C foliations indicate a left handed shear. The white quartz veins in a layer of ferroan dolomite, occupy extension fractures which also indicate a left handed sense of shear. (D) and (E) Folds in the ankerite unit; bar 10 cm. The sense of overturning of the folds is the same as that illustrated in (A); The fold in (D) is from the east end of the drift, and (E) is from the west end of the drift.



host rock. Gold occurs in association with iron sulphides in the iron formation and more rarely with iron oxides or carbonates. Examples include: the Lupin deposit, Contwoyto Lake (Kerswell, 1984); the Vubichikewe deposit, Zimbabwe (Fripp, 1976); the B-zone, Cullaton Lake (Page and Roberts, 1984). The precise association of gold with iron sulphides, and the occurrence of the sulphides in sedimentary laminations, has been interpreted as evidence for co-precipitation of gold and iron sulphides in the sedimentary environment. Phillips *et al.* (1984), however, have documented the replacement of beds of magnetite in oxide iron formation, by gold-bearing iron sulphides, adjacent to quartz veins. The iron sulphides are clearly not sedimentary. Similar structures have been described from the MacLeod-Cockshutt deposit in Geraldton, Ontario (Macdonald, 1984), and the Timmins district (Fyon *et al.*, 1983b). Macdonald (1984) points out that the gold at MacLeod-Cockshutt is in quartz-ankerite veins, and in iron formation within 50 cm of the veins. The veins occupy zones of brittle failure associated with folds in the iron formation. Macdonald (1984) also describes a spatial relationship between alteration of the iron formation and the veins. These relationships have not been recorded from the Lupin deposit and the B-zone, Cullaton Lake, but nevertheless, they seriously question the interpretation of syngensis of gold associated with banded iron formations.

**Wall Rock Alteration**

The alteration of igneous rocks, associated with deposits in low-grade greenschist facies rocks, is characterized by hydrolysis and carbonatization of ferromagnesian minerals and

oxides. In mafic igneous rocks, the greenschist assemblage of actinolite-epidote-albite-quartz gives way to an outer chlorite alteration zone characterized by the assemblage chlorite-calcite, and an inner carbonate zone of ferroan dolomite-sericite-pyrite-quartz. The sequence of mineral changes for ultramafic and felsic igneous rocks is very similar (Figure 10). The chlorite alteration zone is of regional extent, with diffuse outer boundaries. It encompasses the linear deformation zones that host the deposits (Figure 2), and extends into the surrounding, less deformed rocks. The carbonate alteration forms comparatively narrow haloes, between less than one metre and tens of metres thick, around individual veins or vein systems. Extensive carbonate alteration is generally due to overlapping of such haloes.

The major components added to the altered rocks are: CO<sub>2</sub>, K, S and H<sub>2</sub>O. The trace elements include: Au, B, As, Rb, W, Mo, Ba and Sb.

The chemical equations given in Table 1 describe the reactions for the transformation of actinolite and epidote to chlorite and calcite in the chlorite zone, and the formation of sericite, ferroan dolomite and iron sulphides in the carbonate zone. The assemblages indicate increasing activity of CO<sub>2</sub> in the fluid in equilibrium with the wallrock. In general, magnesium, calcium, iron and aluminum of the ferromagnesian minerals enter the alteration mineral assemblage with no contribution of these elements from the fluids. Consequently, the original ferro-magnesian mineral content of the rock is a factor in controlling the maximum CO<sub>2</sub> added to the rock, and hence, the degree of carbonatization of the rock.

Sodium is essentially immobile throughout the zones of alteration in the dolerite at the Golden Mile, Kalgoorlie (Phillips, 1986), and is strongly depleted in the carbonate-rich altered mafic rocks at the Dome mine, Timmins (Roberts and Reading, 1981). However, in the McIntyre-Hollinger ore zone, albite (with sericite and ankerite) characterizes the most strongly altered mafic rocks (Smith and Kesler, 1985), and in the Sigma mine, hydrothermal albite replaces white mica (with a concomitant increase in sodium) in the alteration zone immediately adjacent to the veins. Furthermore, albite is a common accessory in veins, and therefore, it is probable that the hydrothermal fluids contain significant sodium. The replacement of sericite by albite (Equation 3, Table 1) is favoured by relatively high  $a_{Na^+} / a_{K^+}$  in the fluids, and by higher temperatures (Hemley and Jones, 1964). These conditions are most likely to be found in the immediate proximity of the vein. Elsewhere in the alteration zone, the comparatively lower activity of sodium may result in the dissolution of albite.

The reactions given in Table 1 imply that the major components (with the exceptions of CO<sub>2</sub>, K, S, H<sub>2</sub>O, and Na<sup>+</sup>) are little changed in the alteration zones. This holds true for the Golden Mile, Kalgoorlie (Phillips, 1986), the mafic rocks in the Dome mine (Roberts and Reading, 1981), and probably other alteration zones in low-grade greenschist facies rocks. In these deposits, major element abundances or ratios may be used with reliability to determine the original rock composition. However, hydrolysis of the ferromagnesian minerals and reaction with carbonate and other ionic species in the fluids to form new minerals, requires that the major elements

	UNALTERED	CHLORITIC	CARBONATE
SERPENTINE	---	---	---
TREMOLITE	---	---	---
TALC	---	+ + + +	---
CHLORITE	---	+ + + +	---
MAGNETITE	---	---	---
DOLOMITE	---	+ + + +	+ + + +
QUARTZ	---	+ +	+ + + +
ALBITE	---	+ +	+ + + +
MUSCOVITE	---	---	+ + + +
PYRITE	---	---	+ + + +

(a)

	UNALTERED	CHLORITIC	CARBONATE
TREM - ACTIN	---	---	---
EPIDOTE	---	---	---
CHLORITE	---	+ + + +	---
QUARTZ	---	+ + + +	---
ALBITE	---	---	---
CALCITE	---	+ + + +	---
DOLOMITE	---	---	+ + + +
MUSCOVITE	---	---	+ + + +
PYRITE	---	---	+ + + +

(b)

	UNALTERED	Ch - Cb - Mus	Cb - Mus	Cb - Ab
ALBITE	---	---	+ + + +	+ +
CHLORITE	---	---	---	---
EPIDOTE	---	---	---	---
QUARTZ	---	---	+ + + +	+ +
CALCITE	---	+ + + +	+ + + +	+ +
MUSCOVITE	---	+ + + +	---	---
PYRITE	---	---	+ + + +	---

(c)

**Figure 10** Stability ranges of minerals in alteration zones in greenschist facies rocks. (a) (upper left) ultramafic host rocks; (b) (above) mafic host rocks. (After Fyon and Crocket, 1982); (c) (lower left) felsic host rocks. (After Robert and Brown, 1986). Ch-Cb-Mus: chlorite-carbonate-white mica zone; Cb-Mus: carbonate-white mica zone; Cb-Ab: carbonate albite zone. + + + : mineral added; - - - (dashes): mineral destroyed; --- (solid line): mineral stable.

pass into solution, thus providing the potential for their redistribution along concentration gradients within the hydrothermal system. In a careful study of mass balance involved in alteration at the Sigma mine, Quebec, Robert and Brown (1986) show that significant amounts of Fe, Mg, Al and Ti are lost from the alteration zones immediately adjacent to the veins. Since these elements are not added to the outer alteration zones, they conclude that they were flushed into the veins where they combined with Si, B and S of the fluids to precipitate minerals such as tourmaline, iron sulphides, chlorite and sericite. Depletions of major cations, in this case Ca, Mg and Na, are also reported from the more highly altered zones (the ferroan dolomite domains) in greenschist facies rocks in the Red Lake district (Andrews *et al.*, 1986; MacGeehan and Hodgson, 1982; Pirie, 1981). Andrews *et al.* (1986) suggest that the extensive silicification in the altered rocks of the Red Lake district may be due to depletion of Ca, Mg and Na.

The few studies available suggest that alteration in amphibolite-grade metamorphic rocks is represented either by mineral assemblages of lower P-T conditions than the metamorphic grade (i.e. a retrograde

assemblage), or by assemblages that reflect the metamorphic grade of the host rocks. An example of the former occurs in the Dupont deposit, Ontario, where chlorite, quartz and carbonate associated with the emplacement of gold, overprints and replaces amphiboles of the earlier high-grade metamorphism (Smith, 1986). Examples of the latter occur in the Dickenson mine, Red Lake district, Ontario (Mathieson and Hodgson, 1984), the Hemlo deposits (Kuhns *et al.*, 1986) and the Kolar gold fields, India (Narayanswami *et al.*, 1960). The alteration in these deposits contains minerals such as biotite, garnet, anthophyllite-cummingtonite, cordierite, gedrite and alumino silicates such as andalusite and staurolite. Carbonatization is rare, and calcite, the predominant carbonate, is principally in the veins. The low carbonate content and the predominance of calcite over dolomite reflects the higher metamorphic grade. The few available data indicate that the alteration zones have been severely depleted in Na, Ca and Mg with enrichment (or residual enrichment) in Si and Al (Mathieson and Hodgson, 1984; Kuhns *et al.*, 1986; Cameron and Hattori, 1985; Andrews *et al.*, 1986).

The fact that the geochemistry of alteration

in amphibolite facies rocks differs from that of low-grade greenschist metamorphic terranes suggests that the alteration assemblages were formed by rock-water reactions at the higher P-T conditions of metamorphism, rather than by simple upgrading of previously altered rocks. Andrews *et al.* (1986) have documented this relationship between alteration and metamorphism, on the regional scale, for the Red Lake district. The alteration assemblages throughout the district reflect increasing thermal gradients toward the batholith contacts, and the authors conclude that "contact thermal metamorphism and hydrothermal alteration occurred as one and the same process" (Andrews *et al.*, 1986, p. 20).

#### Fluid Inclusion and Isotope Data

The composition of the ore-forming fluid, and a possible source for the fluid, may be deduced from the evidence of fluid inclusions in vein material, and the isotopic compositions of the hydrothermal minerals.

**Fluid Inclusions.** Detailed studies of the fluid inclusions in individual deposits are rare. Reconnaissance studies on Canadian deposits (Kerrich, 1983; Walsh *et al.*, 1984) and Australian deposits (Phillips and Groves,

**Table 1** Chemical equations summarizing some of the reactions that take place in alteration zones in deposits in greenschist facies rocks. (From Kerrich, 1983; Phillips, 1986).

(1)	$3\text{Ca}_2(\text{Mg,Fe})_5\text{Si}_8\text{O}_{22}(\text{OH})_2$	$+ 2\text{Ca}_2\text{Al}_3\text{Si}_3\text{O}_{12}(\text{OH})$	$+ 10\text{CO}_2$	$+ 8\text{H}_2\text{O}$	$-$	$3(\text{Mg,Fe})_5\text{Al}_2\text{Si}_3\text{O}_{10}(\text{OH})_8$	$+ 10\text{CaCO}_3$	$+ 21\text{SiO}_2$
	actinolite	epidote	fluid			chlorite	calcite	
(2)	$3(\text{Mg,Fe})_5\text{Al}_2\text{Si}_3\text{O}_{10}(\text{OH})_8$	$+ 15\text{CaCO}_3$	$+ 2\text{K}^+$	$+ 15\text{CO}_2$	$-$	$2\text{KAl}_3\text{Si}_3\text{O}_{10}(\text{OH})_2$	$+ 15\text{Ca}(\text{Mg,Fe})(\text{CO}_3)_2$	$+ 3\text{SiO}_2$
	chlorite	calcite	fluid			sericite	ferroan dolomite	fluid
(3)	$2\text{Fe}_3\text{O}_4$	$+ 6\text{CO}_2$	$-$	$6\text{FeCO}_3$	$+ \text{O}_2$			
	magnetite			siderite				
(4)	$\text{FeCO}_3$	$+ 2\text{H}_2\text{S}$	$-$	$\text{FeS}_2$	$+ \text{CO}_2$	$+ 2\text{H}_2\text{O}$		
	siderite	fluid		pyrite	fluid			
(5)	$\text{Fe}_3\text{O}_4$	$+ 6\text{H}_2\text{S}$	$+ \text{O}_2$	$-$	$3\text{FeS}_2$	$+ 6\text{H}_2\text{O}$		
	magnetite	fluid		pyrite				
(6)	$3\text{NaAlSi}_3\text{O}_8$	$+ \text{K}^+$	$+ 2\text{H}^+$	$-$	$\text{KAl}_3\text{Si}_3\text{O}_{10}(\text{OH})_2$	$+ 6\text{SiO}_2$	$+ 3\text{Na}^+$	
	albite	fluid		sericite	fluid			

1983; Donnelly *et al.*, 1977), show that inclusions are consistently CO<sub>2</sub>-H<sub>2</sub>O bearing. There is a wide range of CO<sub>2</sub>:H<sub>2</sub>O ratios in co-existing inclusions from CO<sub>2</sub>-poor to CO<sub>2</sub>-dominated (Wood *et al.*, 1986; Guha *et al.*, 1982). Wood *et al.* (1986), in their study of the Hollinger-McIntyre vein system, concluded that the wide variation of compositions was due to phase separation during the main stage of mineralization (unmixing of the original fluid to form two immiscible phases), as a result of pressure decrease within the vein system. Thus they were able to equate homogenization temperatures with trapping temperatures. They give an average temperature of 277 ± 48°C for the main period of mineralization. Homogenization temperatures (minimum temperatures) in other deposits vary from 200 to 490°C.

The estimated salinities of the inclusion fluid are low: < 2 wt.% NaCl equivalent (Kerrich, 1983); < 2 to < 4 wt.% NaCl equivalent, (Phillips and Groves, 1983); approximately 1 wt.% NaCl equivalent (Wood *et al.*, 1986). **Light Stable Isotope Compositions.**

**Oxygen isotopes.** With few exceptions, the δ<sup>18</sup>O of vein quartz falls consistently in the narrow range of +10 to +16‰ (Fyon *et al.*, 1983a; Kerrich, 1983; Golding and Wilson, 1983; Kerrich and Watson, 1984), and is typically identical to the quartz of the altered host rock (Kerrich, 1983). The uniformity of the isotopic composition of the quartz of the vein and altered rocks indicates a uniform source for the solutions, external to the environment of the deposit. The δ<sup>18</sup>O of carbonates reported by Fyon *et al.* (1983a) from the Timmins region ranges from +9 to +14.5‰, and by Golding and Wilson (1983) from Kalgoorlie is 12.4 ± 0.5‰.

The isotopic composition of the fluid may be estimated from the fractionation curves for dolomite-water and quartz-water and used in combination with the temperature of formation of the mineral. Estimates of δ<sup>18</sup>O of fluids for a number of Archean deposits range from +4.5 to +12‰ (Colvine *et al.*, 1984; Wood *et al.*, 1986). These values fall within, or are close to, the generally accepted values for magmatic fluids (+5.5 to +10‰; Taylor, 1979), but they also fall within the more extensive range of δ<sup>18</sup>O values for metamorphic fluids. The usefulness of estimates of fluid compositions is also tempered by the fact that the δ<sup>18</sup>O of minerals may be modified by later water-rock reactions, and by the difficulty in obtaining reliable temperature estimates.

**Carbon isotopes.** The carbon isotopic composition of hydrothermal carbonates in the ore are of particular significance since the ore-forming fluids are characterized by CO<sub>2</sub>, and because it is generally accepted that the carbon isotopic compositions of minerals are less vulnerable to modification by later rock-water reactions than oxygen isotopes.

The averaged δ<sup>13</sup>C values for hydrothermal dolomite from 13 deposits in the Timmins area, not associated with carbonaceous sediments, range from -2.4 to -4.4‰ (Fyon *et al.*, 1983a; Wood *et al.*, 1986). The average value for carbonate from the No. 4 vein at Kalgoorlie, is -3.6‰ (Golding and Wilson, 1983).

The calculated δ<sup>13</sup>C for hydrothermal solutions in the temperature range of 200-500°C, under oxidizing conditions such that graphite is absent, and neutral pH, is approximately that of the ferroan dolomite in equilibrium with it (Ohmoto and Rye, 1979). Thus the δ<sup>13</sup>C values of the carbonates quoted above are approximately the same as the δ<sup>13</sup>C of the solutions from which they were precipitated.

**Hydrogen isotopes.** Hydrogen isotopic data on vein quartz, minerals and fluid inclusions are reported from the Timmins district (Fyon *et al.*, 1983a), the Homestake mine (Rye and Rye, 1974), and the Macassa mine, Kirkland Lake (Kerrich and Watson, 1984). The δD values are as follows: Timmins: +6 to -50‰; Homestake: -55.8 to -12‰; Macassa mine: -60 to -105‰. The data at the Macassa mine were obtained in conjunction with oxygen isotope data, and Kerrich and Watson (1984) conclude that the ores were precipitated from solutions with δ<sup>18</sup>O of +7 to +9.6‰, and δD values of -35 to -85‰, over the temperature range of 380-490°C.

**Sulphur isotopes.** Sulphur isotope data give some indication of the chemistry of the ore fluids and the conditions of deposition of gold. They provide very limited information on the source of the fluids. Values of δ<sup>34</sup>S of iron sulphides from Canadian and Zimbabwean deposits, and the Homestake mine (Crocket and Lavigne, 1984; Wanless *et al.*, 1960; Rye and Rye, 1974; Lambert *et al.*, 1984; Wood *et al.*, 1986; Patison *et al.*, 1986) fall within the narrow range of -0.7 to +7‰. The isotopic values are not unique in as much as they fall within the broad range of many metal sulphide deposit types, but the restricted range of values is unique. For example, Thode and Goodwin (1983) found that the δ<sup>34</sup>S values in carbonaceous chert and siderite facies iron formation from the Helen mine, Michipicoten, Ontario, vary by as much as 30‰ S, and approximately half of the values are isotopically light sulphur. The narrow range around 0‰ suggests that the sulphur of the fluids was in a reduced form.

In contrast to the results for the gold deposits given above, Lambert *et al.* (1984) record values of -2 to -8‰ at the Golden Mile, Kalgoorlie; and in the Hemlo deposit, Ontario, Cameron and Hattori (1985) report values that range from approximately 0 to -17.5‰. In the Hemlo deposit, there is a remarkably strong correlation between the abundance of gold and the depletion of <sup>34</sup>S in pyrite and barite (increasing negative values). This is convincing evidence that

pyrite and gold were deposited contemporaneously (Cameron and Hattori, 1985). (However, there is no correlation between the abundance of gold and the abundance of pyrite.) The evidence from Hemlo and Kalgoorlie suggests that gold was precipitated from a partially oxidized solution, in which <sup>34</sup>S is fractionated into sulphate, and iron sulphide is accordingly depleted in the heavier isotope.

**Source of the Fluids.** The proposed sources for the hydrothermal fluids are: metamorphic fluids (Kerrich, 1983; Phillips and Groves, 1983, 1984); juvenile fluids formed by granulitization of the lower crust and/or degassing of the upper mantle (Colvine *et al.*, 1984); magmatic hydrothermal fluids (Wood *et al.*, 1984; Burrows and Spooner, 1985; Hodgson and MacGeehan, 1982; Hodgson, 1982); re-circulated sea water (Hutchinson and Burlington, 1984).

The low chloride content and high carbonate content of the solutions make it very unlikely that the fluids are re-circulated sea water or connate water. Sea water, trapped in volcanic rocks or re-charging into a thermal system, would quickly lose carbon dioxide by reactions with calcium-bearing clay minerals (Thompson, 1971), and the salinity of the water (3.6% NaCl in modern sea water) would tend to increase as a result of water-rock reactions.

The compositions of fluids in metamorphic rocks are comparable in several respects with ore-forming fluids. Salinities of fluids from inclusions in metamorphic rocks are generally low, and the CO<sub>2</sub>:H<sub>2</sub>O ratio increases from the greenschist facies, where the fluids are H<sub>2</sub>O dominated, to the granulite facies, where they are almost pure CO<sub>2</sub> (Crawford, 1981; Touret, 1981). The CO<sub>2</sub> of metamorphic fluids is either of internal origin (produced by decarbonation reactions, or by the oxidation of carbonaceous material), or it is derived from an external deep-seated source: the degassing of the mantle (Crawford, 1981). Carbon dioxide generated by prograde decarbonation reactions is enriched in <sup>13</sup>C by 3-5‰ with respect to the starting material (Sheppard and Schwarz, 1970). Thus CO<sub>2</sub> from calcite precipitated at low temperatures in volcanic rocks on the sea floor (0 ± 3‰), will be enriched to between +3 and +5‰ (Colvine *et al.*, 1984). In order to attain the estimated carbon isotopic composition of gold ore fluids (-2.4 to -4.4‰), the fluid formed by decarbonation would be required to mix with fluids from other sources or reservoirs (Kerrich, 1983). The uniformity of the isotopic composition of hydrothermal carbonates argues against such a fluid mixing model (Colvine *et al.*, 1984).

The fluids associated with granulization are a potential source of hydrothermal fluids. CO<sub>2</sub>-rich inclusions are ubiquitous in granulites over a wide range of rock compositions,

prompting Touret (1981) to suggest an external source (juvenile fluids from the mantle) as a control to the fluid phase in these high-grade metamorphic rocks. The compositions of the granulite-associated fluids are comparable with the more CO<sub>2</sub>-rich fluids recognized in gold deposits. However, if these are the result of phase separation from a more H<sub>2</sub>O-rich parent fluid (Wood *et al.*, 1986), then the transformation of the metamorphic fluids to ore-forming fluids will require significant dilution.

The CO<sub>2</sub> of juvenile fluids, based on the isotopic studies of carbonatites and diamonds, is generally assumed to have  $\delta^{13}\text{C}$  values of between -4 and -8‰ (Taylor *et al.*, 1967; Deines, 1970; Deines and Gold, 1973). Pineau *et al.* (1976) interpreted carbon ( $\delta^{13}\text{C} = -7.6\text{‰}$ ), in fluid inclusions from the Mid-Atlantic ridge, to be of deep-seated origin. The isotopic composition of granulite-associated fluids and the identification of the isotopic signature of the proposed juvenile fluid is not unequivocal. Kruegen (1980), in a study of the Naxos metamorphic terrane in Greece, identified a population of fluids, which occur in low-grade to high-grade schists, and which have  $\delta^{13}\text{C}$  of -1 to -5‰, as probably of external mantle origin. These values for  $\delta^{13}\text{C}$  of juvenile fluids are comparable to the deduced value of -2.4 to -4.4‰ for ore fluids.

Magmatic hydrothermal fluids are not generally considered to have the low salinities, and the high CO<sub>2</sub> contents associated with the fluids of gold deposits. However, Wood *et al.* (1984) point out that the Boss Mountain deposit, British Columbia (molybdenum), the Logtung deposit, Yukon (tungsten, molybdenum), the Mink Lake deposit, Ontario (molybdenum), and Tanco, Manitoba (antimony, tin), all of which are generally believed to be of magmatic-hydrothermal origin, contain CO<sub>2</sub>-bearing fluid inclusions. Higgins (1980) also notes an association of CO<sub>2</sub> fluids with lode tungsten deposits. As a generalization, CO<sub>2</sub>-rich magmatic hydrothermal fluids appear to be associated with molybdenum and tungsten, and these are common trace elements in gold deposits.

Burrows and Spooner (1985) describe alteration zones in the Mink Lake deposit, that are closely associated with igneous intrusions, which consist of carbonate alteration and involve the enrichment of sodium and potassium. The  $\delta^{13}\text{C}$  values of carbonates in the altered rocks (-2.7 to -3.9‰) are within the range of values from carbonates in gold deposits. Indeed, the deduced carbon isotopic composition of the ore-forming fluids is more consistent with a magmatic reservoir (-3 to -7‰; Hoefs, 1980) than any other probable source.

The available data is not sufficient to define a source for the mineralizing fluids of Archean lode gold deposits with much conviction. However, the compositions of the fluid inclusions and the compositions of the fluids as deduced from isotopic data point to a magmatic-hydrothermal source.

### Solubility of Gold

Gold chloride complexes are stable in strong saline brines, and their stability increases with temperature (Henley, 1973). However, the chloride-poor fluid inclusions and the lack of base metals in the deposits argue against chloride brines as the ore-forming solutions. Seward (1973, 1984) has shown experimentally that gold thio-complexes are stable to at least 300°C and that they dominate the transport of gold in geothermal fields in New Zealand. Data on the stability of base metal thio-complexes are few, but the available data indicate that in alkali solutions, with low sulphur content, base metals will not be as soluble as gold, thus providing a mechanism for the separation of base metals and gold in hydrothermal solutions passing through mafic rocks (Hodgson and MacGeehan, 1982).

The calculated solubilities for gold in Figure 11 indicate that neutral solutions with low concentrations of total sulphur are capable of transporting gold in comparatively high concentrations as the thio-complex. The conditions that bring about saturation and precipitation are probably more critical. The solubility of gold in the thio-complex state increases with the fugacity of oxygen up to the boundary between the fields of reduced and oxidized sulphur (Figure 11). At higher oxygen fugacities, sulphate is the dominant species, and with the decrease in the activity of reduced sulphur species, the solubility of gold in the thio-complex decreases markedly. Oxidation of the fluids is therefore an efficient mechanism for the precipitation of gold. Gold may also be precipitated by changes of pH (an increase in the pH of the solution may occur as the result of loss of carbon dioxide by pressure decrease); a decrease of temperature; or by the reduction in the activity of reduced sulphur by reaction with iron in the host rock to precipitate iron sulphide, and consequent destabilization of the thio-complex.

### Source of Gold

With the exception of the magmatic hydrothermal model, none of the various models for the genesis of the ore-forming solutions includes a specific source of gold. The most obvious source is the rocks of the greenstone belt. Pyke (1976), noting the proximity of gold deposits to ultramafic rocks, suggested these rocks as the "source bed" for gold. This is not supported by the data on unaltered rocks; the abundance of gold in ultramafic komatiites is of the same order as other primary igneous rocks: 0.5-2 ppb (Tilling *et al.*, 1973; Anhaeuser *et al.*, 1975; Kwong and Crocket, 1978). However, the distribution of gold in Precambrian volcanic rocks is not uniform. Saager and Meyer (1984) and Saager *et al.* (1982) identified two statistical populations: a background population of approximately 1 ppb, in which gold is probably associated with silicates and oxides; and an excess value population of higher, more variable values, in which gold is associated with

sulphides. In volcanic rocks, the threshold value is 6.8 ppb, and 19% of the data set are in the excess value population.

An explanation for the bimodal distribution of gold may be found in the work of Keays and Scott (1976) who showed that in modern oceanic basalts, loosely attached, intracrystalline gold and sulphur from magmatic sulphides are mobilized, by the reaction of sea water with the still hot lava, from the crystalline interiors of pillows to the glassy rims. Keays (1984) concluded that similar processes operated in the Precambrian, and that the gold leached from the volcanics was probably fixed in sulphide-bearing, interflow sediments. Bavinon and Keays (1978) report as much as 150 ppb Au in sediments at Kambalda, and similarly elevated values are recorded from sediments in southern Africa (Saager *et al.*, 1982) and the Red Lake district (MacGeehan and Hodgson, 1982; Lavigne and Crocket, 1983). Keays (1984), however, does not suggest that remobilized gold on the sea floor would normally concentrate as ore deposits, but that it would provide elevated concentrations of gold in association with sulphides, and as such it would be readily accessible for later concentration.

Keays (1984) has suggested that Archean komatiitic liquids had a greater capacity than younger, lower temperature magmatic systems, to dissolve sulphur (and with it gold) and thus transfer these elements from the mantle into the crust.

### Discussion

As a result of an increase in exploration activity and research, a large amount of information on gold deposits has been published recently. Consequently considerable progress has been made in defining the basic geological setting of the deposits, but, understandably, hypotheses of genesis are in a state of flux. In the following, aspects of the principal genetic models are briefly reviewed.

The volcanic syngenetic-remobilization model is summarized by Hutchinson and Burlington (1984). According to the model, gold is concentrated in the crust by volcanic-related processes, principally by chemical precipitation in exhalite sediments and Algoman-type banded iron formation. The wall rock alteration is assumed to be related to this primary process. Gold, quartz and associated minerals are remobilized from the sediments to vein structures by post-depositional processes which may include: compaction and diagenesis of the auriferous sediments; deformation and metamorphism; and the deformation-metamorphic processes associated with the emplacement of igneous intrusions.

The model has been brought into question by the following: (a) the re-interpretation of gold-bearing layered units, which were previously considered to be sediments, as sheared rocks with introduced vein material; (b) the recognition that in many deposits in

Algoman-type iron formation, primary magnetite has been replaced by gold-bearing iron sulphides; and (c) it has not been possible to relate the geometry of the altered rocks, or the geochemical gradients in the alteration, to the type of footwall alteration that may be expected in a deposit emplaced at surface. Consequently, many of the units that were previously considered to be gold-bearing sediments are being re-evaluated.

The more obvious and well-established features of gold deposits point unequivocally to emplacement at depth. These include: the distribution of the deposits and the associated alteration in tabular deformation zones of regional dimensions; the association of the veins with progressive deformation in these zones; and evidence (admittedly less well documented) that the geochemistry of alteration assemblages of deposits may reflect the P-T conditions of regional metamorphism. It is evident that the deposits are related to regional-scale geological features, which implies that ore genesis is related to regional-scale processes.

The generation of the fluids by decarbonation and dehydration reactions at the base of the greenstone sequence in the amphibolite facies is compatible with the relationship of the deposits to regional geological features (Kerrick, 1983; Phillips and Groves, 1983; Groves *et al.*, 1984). According to the model, the deformation zones serve as conduits,

and the rise of the fluids to lower P-T conditions bring them into disequilibrium with some of their host rocks. Thus emplacement would be controlled in part by the transition across metamorphic boundaries (Groves *et al.*, 1984).

Principally because of the association of felsic porphyries with gold deposits, a magmatic hydrothermal source for the ore fluids was probably the most popular theory among Canadian geologists until the late 1960s. Recently, as more evidence has indicated that CO<sub>2</sub>-rich fluids may be generated by magmatic processes, the theory has received renewed attention. Macdonald and Hodgson (1986) have pointed out that geochemical features of gold deposits, such as the addition of alkalis to the altered rocks, and the associated elements B, Mo, W, As and Sb, are typical of deposits generally accepted to be of magmatic hydrothermal origin. In their study of deposits in the Temagami district, Fyon and Crocket (1986) describe the zoning of occurrences within a shear zone as being spatially related to late granitoid intrusions; Mo-Cu veins occur closest to the contact of the intrusion, and Cu-Zn-Au and Au zones occur progressively away from the intrusion. Macdonald (1984) reports a similar Mo, Cu, Au zonation related to large felsic intrusions in the Geraldton district. Mason and Melnik (1986) describe similar zoning, but around a comparatively small porphyry

body, in the Hollinger-McIntyre vein system in Timmins. Mason and Melnik (1986) propose a porphyry-type model in which the gold vein mineralization is peripheral to a porphyry-type hydrothermal system centered on a pipe-like zone of copper stockwork orebodies within the Pearl Lake porphyry. They also conclude that mineralization preceded the regional deformation. In contrast, Wood *et al.* (1986) and Burrows and Spooner (1986) in their study of the same deposit, concluded that mineralization post-dated regional deformation, and that the hydrothermal system is not related to the porphyry bodies. They propose a more remote, magmatic source: the "domal tonalite gneiss-granodiorite-quartz-monzonite-type material which intrudes the lower part of Archean greenstone belts" (Wood *et al.*, 1986, p. 78).

It is apparent that the geological evidence concerning the timing of gold deposits in relationship to the various intrusive igneous events and deformation may be ambiguous or incomplete in some environments. These ambiguities may be appreciated in the light of the conclusions of Andrews *et al.* (1986), from their study of the Red Lake district, that contact metamorphism, shear deformation and alteration were all broadly coeval and linked to batholith emplacement. Thus the emplacement of gold deposits is linked to the regional structural, metamorphic and intrusive igneous history of the greenstone belt. This is similar to the conclusion reached by Helmstaedt and Padgham (1986) regarding the relationship of gold deposits to the igneous, structural and metamorphic development of the Yellowknife district, Northwest Territories. Andrews *et al.* (1986, p. 21) point out that the ore-forming fluids "could have had their source in metamorphic dehydration and decarbonation ahead of the rising diapirs, and also magmatic degassing from the diapirs themselves."

#### Acknowledgements

An earlier version of the manuscript was critically reviewed by Patricia Sheahan of Konsult International Inc., Soussan Marmont of the Ontario Geological Survey, and Lee Barker of Lacana Mining. I am grateful to Michael Gray, President of Queenston Gold Mines and Dean Rogers of Dome Mines for allowing me to include previously unpublished information in this paper. The structural relationships at the Upper Canada Mine were first pointed out to me by Terry Bottril, Consulting Geologist, and subsequently described in a B.Sc. thesis by Paul Stewart of the University of Waterloo. I acknowledge financial support from the Ontario Geological Survey Geoscience Research Grant Program and grants from Energy, Mines and Resources, Canada.

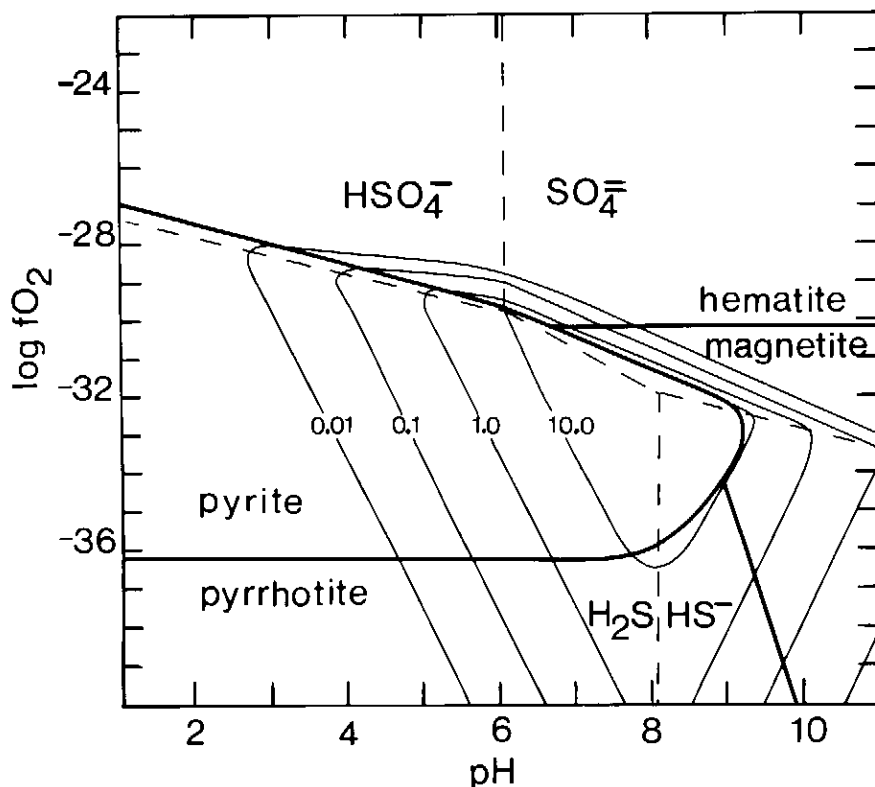

**Figure 11** Calculated gold solubilities as a function of pH and log fO<sub>2</sub>. Gold in the thio-complex Au(HS)<sub>2</sub><sup>-</sup>. Contours are in ppm. Temperature: 300°C; total sulphur 0.05 m. (Data from Seward, 1973 and 1984).

## References

- Andrews, A.J., Hugon, H., Durocher, M., Corfu, F. and Lavigne, M.J., 1986, The anatomy of a gold-bearing greenstone belt: Red Lake, Northwestern Ontario, in Macdonald, A.J., ed., Proceedings of Gold '86, an International Symposium on the Geology of Gold: Toronto, 1986, p. 3-22.
- Andrews, A.J. and Wallace, H., 1983, Alteration, metamorphism and structural patterns associated with Archean gold deposits — preliminary observations in the Red Lake area, in Colvine, A.C., ed., The Geology of Gold in Ontario, Ontario Geological Survey, Miscellaneous Paper 110, p. 111-122.
- Anhaeusser, C.R., Fritz, K., Fyfe, W.S. and Gill, R.C.O., 1975, Gold in "primitive" Archean volcanics: Chemical Geology, v. 16, p. 129-135.
- Archambault, G., 1985, Archean wrench fault tectonics and structural evolution of the Blake River Group, Abitibi Belt: discussion: Canadian Journal of Earth Sciences, v. 22, p. 943-945.
- Baragwanath, W., 1953, Ballarat goldfields, in Edwards, A.B., ed., Geology of Australian ore deposits, Australasian Institute of Mining and Metallurgy, Melbourne, p. 986-1002.
- Barnett, E.S., Hutchinson, R.W., Adamcik, A. and Barnett, R., 1982, Geology of the Agnico Eagle gold mine, Quebec, in Hutchinson, R.W., Spence, C.D. and Franklin, J.M., eds., Precambrian Sulphide Deposits, H.S. Robinson Memorial Volume, Geological Association of Canada, Special Paper 25, p. 403-426.
- Bavinton, O.A. and Keays, R.R., 1978, Precious metal values from interflow sedimentary rocks from the komatiite sequence at Kambalda, Western Australia: Geochimica et Cosmochimica Acta, v. 42, p. 1151-1163.
- Boyle, R.W., 1961, The geology, geochemistry and origin of the gold deposits of the Yellowknife district: Geological Survey of Canada, Memoir 310, 193 p.
- Boyle, R.W., 1979, The geochemistry of gold and its deposits: Geological Survey of Canada, Bulletin 280, 584 p.
- Burrows, D.R. and Spooner, E.T.C., 1986, The McIntyre Cu-Au deposit, Timmins, Ontario, Canada, in Macdonald, A.J., ed., Proceedings of Gold '86, an International Symposium on the Geology of Gold: Toronto, 1986, p. 23-39.
- Burrows, D.R., Wood, P.C. and Spooner, E.T.C., 1985, Carbon isotope evidence for a magmatic origin for Archean gold-quartz vein ore deposits: Nature, v. 321, p. 851-854.
- Burrows, D. R. and Spooner, E.T.C., 1985, Generation of an Archean H<sub>2</sub>O-CO<sub>2</sub> fluid enriched in Au, W and Mo by fractional crystallization in the Mink Lake intrusion, N.W. Ontario: Geological Society of America, Abstracts with Program, v. 17, p. 536.
- Cameron, E.M. and Hattori, K., 1985, The Hemlo gold deposit, Ontario: a geochemical and isotopic study: Geochimica et Cosmochimica Acta, v. 49, p. 2041-2050.
- Charlewood, G.H., 1964, Geology of Deep Developments on the Main Ore Zone at Kirkland Lake, NTS 42A/1, Timiskaming District, Ontario: Ontario Department of Mines, Geological Circular 11, 49 p.
- Cherry, M.E., 1983, Association of gold and felsic intrusions - examples from the Abitibi belt, in Colvine, A.C., ed., The Geology of Gold in Ontario: Ontario Geological Survey, Miscellaneous Paper 110, p. 48-55.
- Colvine, A.C., Andrews, A.J., Cherry, M.E., Durocher, M.E., Fyon, A.J., Lavigne, M.J., Macdonald, A.J., Marmont, S., Poulsen, K.H., Springer, J.S. and Troop, D.G., 1984, An integrated model for the origin of Archean lode gold deposits: Ontario Geological Survey, Open File Report 5524, 99 p.
- Cooke, D.L. and Moorhouse, W.W., 1969, Timiskaming volcanism in the Kirkland Lake Area, Ontario, Canada: Canadian Journal of Earth Sciences, v. 6, p. 117-132.
- Crawford, M.L., 1981, Fluid inclusions in metamorphic rocks - low and medium grade, in Hollister, L.S. and Crawford, M.L., eds., Short course in fluid inclusions: applications to petrology: Mineralogical Association of Canada, p. 157-181.
- Crocket, J.H. and Lavigne, M.J., 1984, Sulphur sources in the Dickenson gold mine as suggested by sulphur isotopes, in Foster, R.P., ed., Gold '82: Zimbabwe Geological Society, Special Publication No. 1, p. 417-434.
- Crocket, J.H., Cowan, P. and Kusmirski, R.T.M., 1981, Gold content of volcanic-hosted interflow sedimentary rocks in the Red Lake area: implications on ore genesis at the Dickenson mine, in Pye, E.G. and Roberts, R.G., eds., Genesis of Archean, volcanic hosted gold deposits: Ontario Geological Survey, Miscellaneous Paper 97, p. 128-143.
- Deines, P., 1970, The carbon and oxygen isotopic composition of carbonates from the Oka carbonatite complex, Quebec, Canada: Geochimica et Cosmochimica Acta, v. 34, p. 1199-1225.
- Deines, P. and Gold, D.P., 1973, The isotopic composition of carbonatite and kimberlite carbonates and their bearing on the isotopic composition of deep-seated carbon: Geochimica et Cosmochimica Acta, v. 37, p. 1709-1733.
- Dimroth, E., Imreh, L., Rocheleau, M. and Goulet, N., 1982, Evolution of the south-central part of the Archean Abitibi Belt, Quebec. Part I: Stratigraphy and paleogeographic model: Canadian Journal of Earth Sciences, v. 19, p. 1729-1758.
- Donnelly, T.H., Lambert, I., Oehler, D.Z., Halleberg, J., Hudson, D.R., Smith, J.W., Bavinton, O.A. and Golding, L., 1977, A reconnaissance study of stable isotope ratios in Archean rocks from the Yilgarn Block, Western Australia: Journal of the Geological Society of Australia, v. 24, p. 409-420.
- Fehlberg, B. and Giles, C.W., 1984, Archean volcanic exhalative gold mineralization at Spargoville, Western Australia, in Foster, R.P., ed., Gold '82: Zimbabwe Geological Society, Special Publication No. 1, p. 285-304.
- Fripp, R.E.P., 1976, Stratabound gold deposits in Archean banded iron formation, Rhodesia: Economic Geology, v. 71, p. 58-75.
- Fryer, B.J. and Hutchinson, R.W., 1976, Generation of metal deposits on the sea floor: Canadian Journal of Earth Sciences, v. 13, p. 126-135.
- Fryer, B.J., Kerrich, R., Hutchinson, R.W., Pierce, M.G., and Rogers, D.S., 1979, Archean precious metal hydrothermal systems, Dome Mine, Abitibi greenstone belt. I. Patterns of alteration and metal distribution: Canadian Journal of Earth Sciences, v. 16, p. 421-439.
- Fyon, J.A. and Crocket, J.H., 1982, Gold exploration in the Timmins district using field and lithochemical characteristics of carbonate alteration zones, in Hodder, R.W. and Petruk, W., eds., Geology of Canadian Gold Deposits: Canadian Institute of Mining and Metallurgy, Special Paper 24, p. 113-129.
- Fyon, A.J. and Crocket, J.H., 1986, Gold mineralization in Strathly Township, Temagami area, Ontario, in Chater, A.M., ed., Gold '86, an International Symposium on the Geology of Gold: Toronto, 1986, Poster paper abstracts, p. 44.
- Fyon, J.A., Crocket, J.H. and Schwarcz, H.P., 1983a, Application of stable isotope studies to gold metallogeny in the Timmins-Porcupine camp, NTS 42A, Cochrane District: Ontario Geological Survey, Open File Report 5464, 182 p.
- Fyon, J.A., Crocket, J.H. and Schwarcz, H.P., 1983b, The Carshaw and Malga iron-formation hosted gold deposits of the Timmins area, in Colvine, A.C., ed., The Geology of Gold in Ontario: Ontario Geological Survey, Miscellaneous Paper 110, p. 98-110.
- Gibbins, W., 1981, Gold and Precambrian iron formation in the Northwest Territories, in Morton, R.D., ed., Proceedings of the Gold Workshop: Yellowknife Gold Workshop Committee, Yellowknife, Northwest Territories, p. 258-287.
- Gibson, I.L., Roberts, R.G. and Maloney, J.A., 1982, Felsic volcanism and the origin of gold deposits at Timmins and Kirkland Lake: Geological Association of Canada - Mineralogical Association of Canada, Program with abstracts, v. 7, p. 52.
- Golding, S.D. and Wilson, A.F., 1983, Geochemical and stable isotope studies of the No 4 lode, Kalgoorlie, Western Australia: Economic Geology, v. 78, p. 438-450.
- Goodwin, A.M. and Ridler, R.H., 1970, The Abitibi orogenic belt, in Baer, A.J., ed., Symposium on basins and geosynclines of the Canadian Shield: Geological Survey of Canada, Paper 70-40, p. 1-24.
- Graves, M.C. and Zentilli, M., 1982, A review of the geology of gold in Nova Scotia, in Hodder, R.W. and Petruk, W., ed., Geology of Canadian Gold Deposits: Canadian Institute of Mining and Metallurgy, Special Paper 24, p. 233-242.
- Groves, D.L., Phillips, G.N., Ho, S.E., Henderson, C.A., Clark, M.E. and Wood, G.M., 1984, Controls on distribution of Archean hydrothermal gold deposits in Western Australia, in Foster, R.P., ed., Gold '82: Geological Society of Zimbabwe, Special Publication No. 1, p. 689-712.
- Guha, J., Archambault, G. and Leroy, J., 1983, A correlation between the evolution of mineralizing fluids and the geomechanical development of a shear zone as illustrated by the Henderson Z Mine, Quebec: Economic Geology, v. 78, p. 1605-1618.

- Guha, J., Gauthier, A., Vallee, M., Descarreaux, J. and Lange-Brard, F., 1982, Gold mineralization patterns at the Doyon mine (Silverstack), Bousquet, Quebec, in Hodder, R.W. and Petruk, W., eds., *Geology of Canadian Gold Deposits*: Canadian Institute of Mining and Metallurgy, Special Paper 24, p. 50-57.
- Helmstaedt, H. and Padgham, W.A., 1986, A new look at the stratigraphy of the Yellowknife Supergroup at Yellowknife, N.W.T. - implications for the age of gold-bearing shear zones and Archean basin evolution: *Canadian Journal of Earth Sciences*, v. 23, p. 454-475.
- Hemley, J.J. and Jones, W.P., 1964, Chemical aspects of hydrothermal alteration with emphasis on hydrogen metasomatism: *Economic Geology*, v. 59, p. 538-569.
- Henley, R.W., 1973, Solubility of gold in hydrothermal chloride solutions: *Chemical Geology*, v. 11, p. 73-87.
- Higgins, N.C., 1980, Fluid inclusion evidence for the transport of tungsten by carbonate complexes in hydrothermal solutions: *Canadian Journal of Earth Sciences*, v. 17, p. 823-830.
- Hodgson, C.J., 1982, Gold deposits of the Abitibi Belt, Ontario, in Wood, J., White, O.L., Barlow, R.B. and Colvine, A.C., eds., *Summary of field work, 1982*, Ontario Geological Survey, Miscellaneous Paper 106, p. 192-197.
- Hodgson, C.J., 1983, Preliminary report on a computer file of gold deposits of the Abitibi belt, Ontario, in Colvine, A.C., ed., *The Geology of Gold in Ontario*: Ontario Geological Survey, Miscellaneous Paper 110, p. 11-37.
- Hodgson, C.J. and MacGeehan, P.J., 1982, A review of the geological characteristics of "gold only" deposits in the Superior Province of the Canadian Shield, in Hodder, R.W. and Petruk, W., eds., *Geology of Canadian Gold Deposits*: Canadian Institute of Mining and Metallurgy, Special Volume 24, p. 211-228.
- Hoefs, J., 1980, *Stable isotope geochemistry*: Springer-Verlag, New York, 208 p.
- Hugon, H. and Schwerdtner, W.M., 1985, Structural signature and tectonic history of deformed gold-bearing rocks in N.W. Ontario: Ontario Geological Survey, Geoscience Research Seminar and Open House, abstracts, p. 2.
- Hutchinson, R.W., 1976, Lode gold deposits: the case for volcanogenic derivation, in *Proceedings Volume, Pacific Northwest Mining and Metals Conference*, Portland, 1975: Oregon Department of Geology and Industrial Minerals, p. 64-105.
- Hutchinson, R.W. and Burlington, J.L., 1984, Some broad characteristics of greenstone belt gold lodes, in Foster, R.P., ed., *Gold '82*: Geological Society of Zimbabwe, Special Publication No. 1, p. 339-372.
- Jensen, L.S., 1985, Stratigraphy and petrogenesis of Archean metavolcanic sequences, southwestern Abitibi Subprovince, Ontario, in Ayres, L.D., Thurston, P.C., Card, K.D. and Weber, W., eds., *Evolution of Archean Supracrustal Sequences*: Geological Association of Canada, Special Paper 28, p. 65-88.
- Karvinen, W.O., 1981, Geology and evolution of gold deposits, Timmins area, Ontario, in Pye, E.G. and Roberts, R.G., eds., *Genesis of Archean, volcanic hosted gold deposits*: Ontario Geological Survey, Miscellaneous Paper 97, p. 29-46.
- Keays, R.R., 1984, Archean gold deposits and their source rocks: the upper mantle connection, in Foster, R.P., ed., *Gold '82*: Geological Society of Zimbabwe, Special Publication Number 1, p. 17-52.
- Keays, R.R. and Scott, R.B., 1976, Precious metals in ocean ridge basalts: implications for basalts as source rocks for gold mineralization: *Economic Geology*, v. 71, p. 705-720.
- Kerrich, R., 1983, Geochemistry of gold deposits in the Abitibi greenstone belt: The Canadian Institute of Mining and Metallurgy, Special Volume 27, 75 p.
- Kerrich, R. and Watson, G.P., 1984, The Macassa Mine Archean lode gold deposit, Kirkland Lake, Ontario: patterns of alteration and hydrothermal regimes: *Economic Geology*, v. 79, p. 104-1130.
- Kerrich, R., Fryer, B.J., Milner, K.J. and Pierce, M.G., 1981, The geochemistry of gold-bearing chemical sediments, Dickenson mine, Ontario: a reconnaissance study: *Canadian Journal of Earth Sciences*, v. 18, p. 624-637.
- Kerswell, J.A., 1984, The Lupin deposit, Contwoyto Lake area, N.W.T.: styles of gold distribution and possible genetic models: Geological Association of Canada - Mineralogical Association of Canada, Program with abstracts, v. 9, p. 78.
- Kreulen, R., 1980, CO<sub>2</sub>-rich fluids during regional metamorphism on Naxos (Greece): carbon isotopes and fluid inclusions: *American Journal of Science*, v. 280, p. 745-771.
- Kuhns, R.J., Sawkins, F.J. and Ito, E., 1986, Alteration associated with the Golden Giant deposit, Hemlo, Ontario: Geological Association of Canada, Annual Meeting, Program with abstracts, v. 11, p. 91.
- Kwong, Y.T.J. and Crocket, J.H., 1978, Background and anomalous gold in rocks of an Archean greenstone assemblage, Kakagi Lake area, northwestern Ontario: *Economic Geology*, v. 73, p. 50-63.
- Lambert, I.B., Phillips, G.N. and Groves, D.L., 1984, Sulphur isotope compositions and genesis of Archean gold mineralization, Australia and Zimbabwe, in Foster, R.P., ed., *Gold '82*: Geological Society of Zimbabwe, Special Publication No. 1, p. 389-416.
- Latulippe, M., 1982, An overview of the geology of gold occurrences and developments in northwestern Quebec, in Hodder, R.W. and Petruk, W., eds., *Geology of Canadian Gold Deposits*, Canadian Institute of Mining and Metallurgy, Special Volume 24, p. 9-14.
- Lavigne, M.J. and Crocket, J.H., 1983, Geology of the East South "C" ore zone, Dickenson mine, Red Lake, in Colvine, A.C., ed., *The Geology of Gold in Ontario*: Ontario Geological Survey, Miscellaneous Paper 110, p. 141-158.
- Macdonald, A.J., 1984, Gold mineralization in Ontario, I: The role of banded iron formation, in Guha, J. and Chown, E.H., eds., *Chibougamau - stratigraphy and mineralization*: Canadian Institute of Mining and Metallurgy, Special Volume 34, p. 412-430.
- Macdonald, A.J. and Hodgson, C.J., 1986, The case for the magmatic-hydrothermal origin of Archean lode gold deposits, in Chater, A.M., ed., *Gold '86*, an International Symposium on the Geology of Gold: Toronto, 1986, Poster paper abstracts, p. 98.
- MacGeehan, P.J. and Hodgson, C.J., 1982, Environments of gold mineralization in the Campbell Red Lake and Dickenson Mines, Red Lake District, Ontario, in Hodder, R.W. and Petruk, W., eds., *Geology of Canadian Gold Deposits*: Canadian Institute of Mining and Metallurgy, Special Paper 24, p. 184-210.
- Mason, R. and Melnik, N., 1986, The anatomy of an Archean gold system - the McIntyre-Hollinger Complex at Timmins, Ontario, Canada, in Macdonald, A.J., ed., *Proceedings of Gold '86*, an International Symposium on the Geology of Gold: Toronto, 1986, p. 40-55.
- Matthews, A. and Beckinsale, R.D., 1979, Oxygen isotope equilibration systematics between quartz and water: *American Mineralogist*, v. 64, p. 232-240.
- Mathieson, N.A. and Hodgson, C.J., 1984, Alteration, mineralization, and metamorphism in the area of the East South "C" ore zone, 24th level of the Dickenson mine, Red Lake, northwestern Ontario: *Canadian Journal of Earth Sciences*, v. 21, p. 35-52.
- Melling, D.R., Watkinson, D.H., Poulsen, K.H., Chorlton, L.B. and Hunter, A.D., 1986, The Cameron Lake gold deposit, Northwestern Ontario, Canada: geological setting, structure and alteration, in Macdonald, A.J., ed., *Proceedings of Gold '86*, an International Symposium on the Geology of Gold: Toronto, 1986, p. 149-169.
- MERQ-QGS, 1983, Lithostratigraphic map of the Abitibi Subprovince: Ministère de l'Énergie et des Ressources, Québec — Ontario Geological Survey, scale 1:500,00; catalogued as "Map 284" in Ontario and "DV-83-16" in Quebec.
- Michie, H., 1967, Hollinger mine, in C.I.M. Centennial Field Excursion, Northwest Quebec and Northern Ontario, p. 111-117.
- Narayanawami, S., Ziauddin, M. and Ramachandra, A.V., 1960, Structural control and localization of gold-bearing lodes, Kolar gold field, India: *Economic Geology*, v. 55, p. 1429-1459.
- Ohmoto, H. and Rye, R.O., 1979, Isotopes of sulphur and carbon, in Barnes, H.L., ed., *Geochemistry of hydrothermal ore solutions*: John Wiley, Toronto, p. 509-567.
- Padgham, W.A., 1981, Gold deposits of the Northwest Territories, in Morton, R.D., ed., *Proceedings of the Gold Workshop*: Yellowknife Gold Workshop Committee, Yellowknife, Northwest Territories, p. 174-201.
- Page, C.E. and Roberts, R.G., 1984, The Cullaton Lake B-Zone deposit, Northwest Territories: geology and geochemistry of a gold-bearing iron formation: Geological Association of Canada - Mineralogical Association of Canada, Program with abstracts, v. 9, p. 94.
- Pattison, E.F., Auerbrei, J.A., Hannila, J.J. and Church, J.F., 1986, Gold mineralization in the Casa-Berardi area, Quebec, Canada, in Macdonald, A.J., ed., *Proceedings of Gold '86*, an International Symposium on the Geology of Gold: Toronto, 1986, p. 170-183.
- Phillips, G.N., 1986, Geology and alteration in the Golden Mile, Kalgoolie: *Economic Geology*, v. 81, p. 779-808.
- Phillips, G.N. and Groves, D.L., 1983, The nature of Archean gold fluids as deduced from gold deposits of Western Australia: *Journal of the Geological Society of Australia*, v. 30, p. 25-39.

- Phillips, G.N. and Groves, D.I., 1984, Fluid access and fluid-wall rock reactions in the genesis of the Archean gold-quartz vein deposit at the Hunt mine, Kambalda, Western Australia. *in* Foster, R.P., ed., *Gold '82: the geology, geochemistry and genesis of gold deposits*: Geological Society of Zimbabwe, Special Publication No. 1, p. 389-416.
- Phillips, G.N., Groves, D.I. and Martyn, J.E., 1984, An epigenetic origin for Archean banded iron-formation hosted gold deposits: *Economic Geology*, v. 79, p. 162-171.
- Pineau, F., Javoy, M. and Bottinga, Y., 1976,  $^{13}\text{C}/^{14}\text{C}$  ratios of rocks and inclusions in popping rocks of the Mid-Atlantic Ridge and their bearing on the problem of isotopic composition of deep-seated carbon: *Earth and Planetary Science Letters*, v. 29, p. 413-421.
- Pirie, J., 1981, Regional geological setting of gold deposits in the Red Lake Area, northwestern Ontario, *in* Pye, E.G. and Roberts, R.G., eds., *Genesis of Archean, volcanic hosted gold deposits*: Ontario Geological Survey, Miscellaneous Paper 97, p. 71-93.
- Platt, J.P., 1983, Progressive refolding in ductile shear zones: *Journal of Structural Geology*, v. 5, p. 619-622.
- Poulsen, K.H., 1983, Structural setting of vein-type gold mineralization in the Mine Centre-Fort Frances area: implication for the Wabigoon subprovince, *in* Colville, A.C., ed., *The Geology of Gold in Ontario*: Ontario Geological Survey, Miscellaneous Paper 110, P. 174-180.
- Poulsen, K.H., Ames, D.E. and Galley, A.G., 1986, Gold mineralization in the Star Lake pluton, La Ronge belt, Saskatchewan: a preliminary report: *Geological Survey of Canada, Current Research, Paper 86-1A*, p. 205-212.
- Poulsen, K.H. and Franklin, J.M., 1981, Copper and gold mineralization in an Archean trondhjemitic intrusion, Sturgeon Lake, Ontario: *Geological Survey of Canada, Current Research, Paper 81-1A*, p. 9-14.
- Pyke, D.R., 1976, On the relationship of gold mineralization and ultramafic volcanic rocks in the Timmins Area, northeastern Ontario: *Canadian Institute of Mining and Metallurgy, Bulletin*, v. 69, p. 79-87.
- Pyke, D.R., 1982, *Geology of the Timmins Area, NTS 42A/6, Cochrane District, Ontario*: Ontario Geological Survey, Report 219, 141 p.
- Ramsay, J.G., 1980, Shear geometry: a review: *Journal of Structural Geology*, v. 2, p. 83-99.
- Rigg, D.M. and Helmstaedt, H., 1981, Relations between structures and gold mineralization in Campbell Red Lake and Dickenson mines, Red Lake area, Ontario, *in* Pye, E.G. and Roberts, R.G., eds., *Genesis of Archean, volcanic hosted gold deposits*: Ontario Geological Survey, Miscellaneous Paper 97, p. 111-127.
- Robert, F. and Brown, A.C., 1986, Archean gold-bearing quartz veins at the Sigma mine, Abitibi greenstone belt, Quebec, Part II: vein paragenesis and hydrothermal alteration: *Economic Geology*, v. 81, p. 595-616.
- Robert, F., Brown, A.C. and Audet, A.J., 1983, Structural control of gold mineralization at the Sigma Mine, Val d'Or, Quebec: *Canadian Institute of Mining and Metallurgy, Bulletin*, v. 76, p. 72-80.
- Roberts, R.G., 1981, The volcanic-tectonic setting of gold deposits in the Timmins area, *in* Pye, E.G. and Roberts, R.G., eds., *Genesis of Archean, volcanic hosted gold deposits*, Ontario Geological Survey, Miscellaneous Paper 97, p. 1-28.
- Roberts, R.G. and Reading, D.J., 1981, The volcanic-tectonic setting of gold deposits in the Timmins district - carbonate-bearing rocks at the Dome mine, *in* Pye, E.G., ed. *Geoscience Research Grant Program, Summary of Research 1980-1981*: Ontario Geological Survey, Miscellaneous Paper 98, p. 222-228.
- Rye, D.M. and Rye, R.O., 1974, Homestake gold mine, South Dakota: I. Stable isotope studies: *Economic Geology*, v. 69, p. 293-317.
- Saager, R. and Meyer, M., 1984, Gold distribution in Archean granitoids and supracrustal rocks from southern Africa: a comparison, *in* Foster, R.P., ed., *Gold '82: Geological Society of Zimbabwe, Special Publication Number 1*, p. 53-70.
- Saager, R., Meyer, M. and Muff, R., 1982, Gold distribution in supracrustal rocks in Archean greenstone belts in Southern Africa and from Paleozoic ultramafic complexes of the European Alps: metallogenic and geochemical implications: *Economic Geology*, v. 77, p. 1-24.
- Sanborn, M. and Schwerdtner, W.M., 1986, The role of brittle-ductile shear in the formation of gold-bearing quartz-carbonate veins in the west carbonate zone of the Cochenour-Willans mine, Red Lake, Ontario: *Geological Association of Canada - Mineralogical Association of Canada, Program with abstracts*, v. 11, p. 123.
- Schwerdtner, W.M., Stone, D., Osadetz, K., Morgan, J. and Stott, G.M., 1979, Granitoid complexes and the Archean tectonic record in the southern part of northwestern Ontario: *Canadian Journal of Earth Sciences*, v. 19, p. 1965-1977.
- Seward, T.M., 1973, Thio-complexes of gold and the transport of gold in hydrothermal ore solutions: *Geochimica et Cosmochimica Acta*, v. 37, p. 379-399.
- Seward, T.M., 1984, The transport and deposition of gold in hydrothermal systems, *in* Foster, R.P., ed., *Gold '86: Geological Society of Zimbabwe, Special Publication No. 1*, p. 165-182.
- Sheppard, S.M.F. and Schwarcz, H.P., 1970, Fractionation of carbon and oxygen isotopes and Mg between co-existing and metamorphic calcite and dolomite: *Contributions to Mineralogy and Petrology*, v. 20, p. 161-198.
- Simpson, C., 1983, Displacement and strain patterns from naturally occurring shear zone terminations: *Journal of Structural Geology*, v. 5, p. 497-506.
- Smith, P.M., 1986, Dupont, a structurally controlled gold deposit in Northwestern Ontario, Canada, *in* Macdonald, A.J., ed., *Proceedings of Gold '86, an International Symposium on the Geology of Gold*: Toronto, 1986, p. 197-212.
- Smith, T.J. and Kesler, S.E., 1985, Relation of fluid inclusion geochemistry to wall rock alteration and lithogeochemical zonation at the Hollinger-McIntyre gold deposit, Timmins, Ontario: *Canadian Institute of Mining and Metallurgy Bulletin*, v. 78, p. 35-46.
- Taylor, H.P., 1979, Oxygen and hydrogen isotope relationships, *in* Barnes, H.L., ed., *Geochemistry of hydrothermal ore deposits*: John Wiley, Toronto, p. 236-272.
- Taylor, H.P., Frechen, J. and Degens, E.T., 1967, Oxygen and carbon isotope studies of carbonates from the Laacher See district, West Germany and the Alno district, Sweden: *Geochimica et Cosmochimica Acta*, v. 31, p. 407-430.
- Tchalenko, J.S., 1968, The evolution of kink-bands and the development of compressive textures in sheared clays: *Tectonophysics*, v. 6, p. 159-174.
- Thode, H.G. and Goodwin, A.M., 1983, Further sulphur and carbon isotope studies of late Archean iron-formation of the Canadian Shield and the rise of sulphate reducing bacteria: *Precambrian Research*, v. 20, p. 337-356.
- Thompson, A.B., 1971,  $p_{\text{CO}_2}$  in low grade metamorphism: zeolite, carbonates, clay mineral, prehnite relations in the system  $\text{CaO-Al}_2\text{O}_3\text{-SiO}_2$ : *Contributions to Mineralogy and Petrology*, v. 33, p. 145-161.
- Tilling, R.I., Gottfried, D. and Rowe, J.J., 1973, Gold abundance in igneous rocks and its bearing on gold mineralization: *Economic Geology*, v. 68, p. 168-186.
- Touret, J., 1981, Fluid inclusions in high grade metamorphic rocks, *in* Hollister, L.S. and Crawford, M.L., eds., *Short course in fluid inclusions: applications in petrology*: Mineralogical Association of Canada, p. 182-208.
- Valliant, R.I., Mongeau, C. and Doucet, R., 1982, The Bousquet pyritic gold deposits, Bousquet Region, Quebec: descriptive geology and preliminary interpretations of genesis, *in* Hodder, R.W. and Petruk, W., eds., *Geology of Canadian Gold Deposits*: Canadian Institute of Mining and Metallurgy, Special Volume 24, p. 41-49.
- Viljoen, M.J., 1984, Archean gold mineralization and komatiites in southern Africa, *in* Foster, R.P., ed., *Gold '82: Geological Society of Zimbabwe, Special Publication No. 1*, p. 595-628.
- Walsh, J.F., Haynes, F.M. and Kesler, S.E., 1984, Fluid inclusion analyses of auriferous vein quartz from the Porcupine district, Ontario: *Geological Association of Canada - Mineralogical Association of Canada, Program with abstracts*, v. 9, p. 114.
- Wanless, R.K., Boyle, R.W. and Lowdon, J.A., 1960, Sulphur isotope investigations of the gold-quartz deposits of the Yellowknife District: *Economic Geology*, v. 55, p. 1591-1621.
- Ward, J.H.W., 1984, Barberton rocks and exhalative gold, *in* Pearton, T.N., ed., *Archean gold, Barberton centenary symposium*, (abstract), p. 26.
- Wood, P.C., Burrows, D.R., Thomas, A.V. and Spooner, E.T.C., 1986, The Hollinger-McIntyre Au-Quartz vein system, Timmins, Ontario, Canada: geologic characteristics, fluid properties and light stable isotopes, *in* Macdonald, A.J., ed., *Proceedings of Gold '86, an International Symposium on the Geology of Gold*: Toronto, 1986, p. 56-80.
- Wood, P.C., Thomas, A.V., Burrows, D.R., Macdonald, A.J., Noble, S.R. and Spooner, E.T.C., 1984,  $\text{CO}_2$ -bearing, low-moderate salinity fluids in Archean gold-quartz-carbonate-(W-Mo) vein deposits and magmatically derived Mo, W, Ta, and Sn mineralization: *Geological Society of America, Abstracts with Program*, v. 16, p. 700.